

# EMC

## Optimum equipotential bonding

### Basis for stable data communication

Products 

Diagnosis 

Monitoring 

Training 

Consulting 

Network Services 





## Content

EMC in fieldbus-related environments – Shielding, earthing, measurement	4
EMC in fieldbus-related environments – Basic principles	6
EMC in fieldbus-related environments – Typical sources of interference	7
EMC in fieldbus-related environments – Definitions	8
EMC in fieldbus-related environments – Reference values	9
Planning for equipotential bonding – Today’s technology	10
Planning for equipotential bonding – Tomorrow’s technology	11
Conductor cables, tin-plated, extra-fine wire and stranded	12
EMClots® fastening elements – stable and conductive	14
EMClip® shield terminal system – direct and with large contact area	16
PROFINET and PROFIBUS cable +FE (functional earth)	17
Symmetrical motor cable SymFlex® EMV-DRIVE/ +FE	18
Leakage current measuring clamp EMCheck® LSMZ I	20
Mesh resistance measuring clamp EMCheck® MWMZ II	21
Intelligent current measuring clamp EMCheck® ISMZ I	22
EMV-INspektor® V2	23
Evaluation EMCheck® ISMZ I and EMV-INspektor® V2	24
PROmanage® NT network monitoring software	26
<b>Product overview</b>	
Infrastructure components	28
Measurement and diagnostic tools	34
Permanent network monitoring	34
Our expertise	35
Measurement   Training	35



# EMC in fieldbus-related environments – Shielding, earthing,

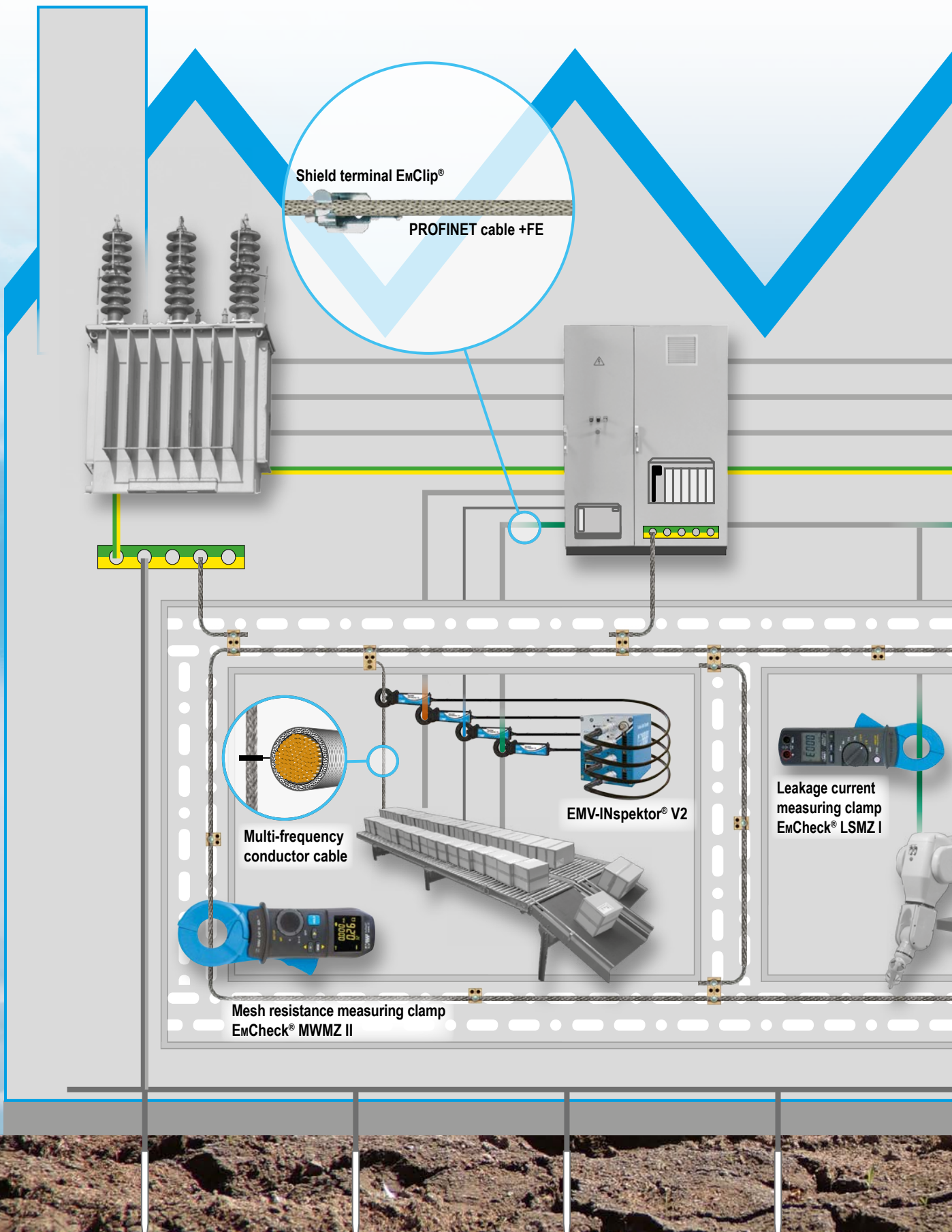

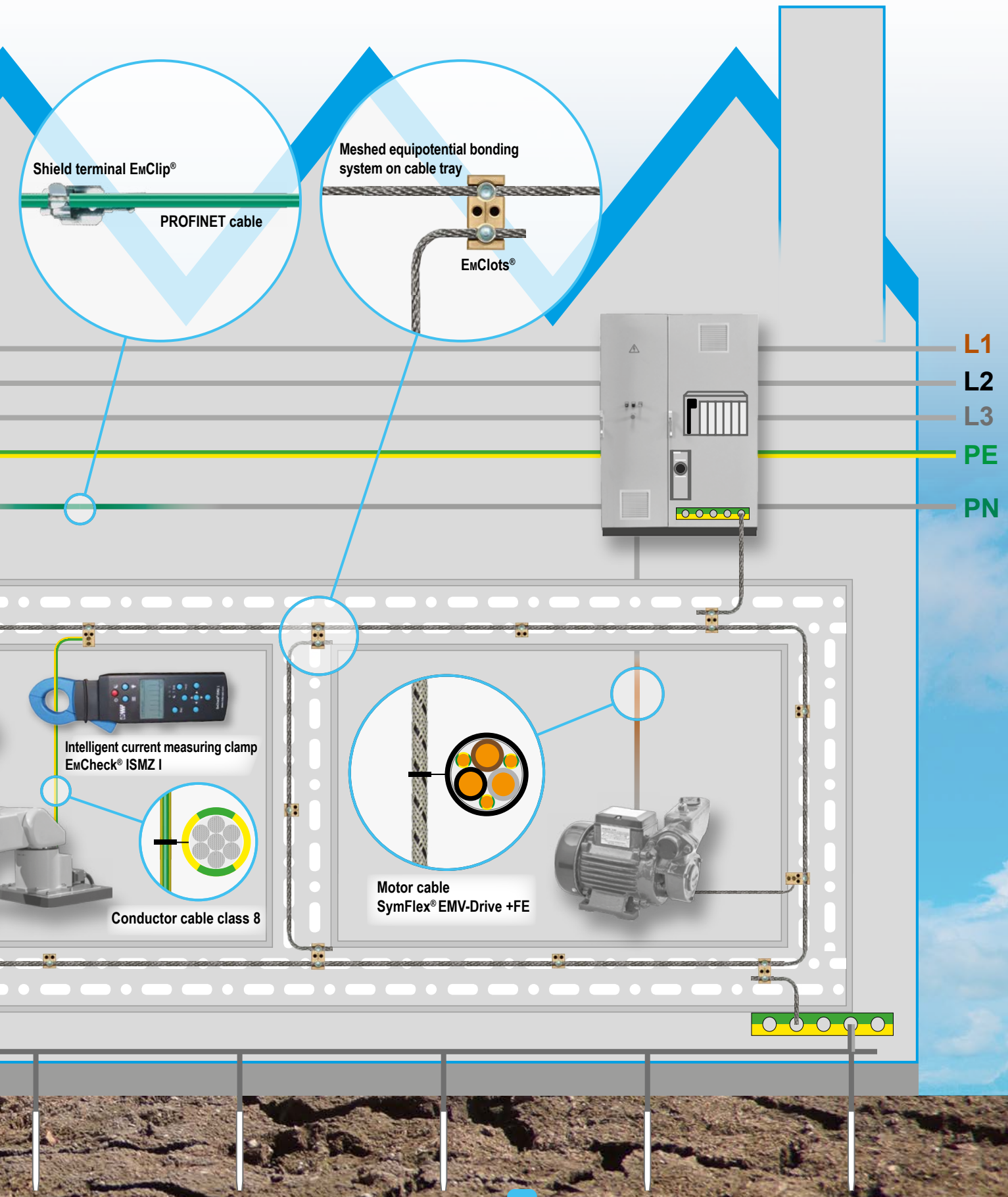



## Basics

Bus modules are generally designed and built to withstand all types of external electromagnetic interference. Certificates by EMC laboratories (EMC = electromagnetic compatibility) are the basis for any product certification.

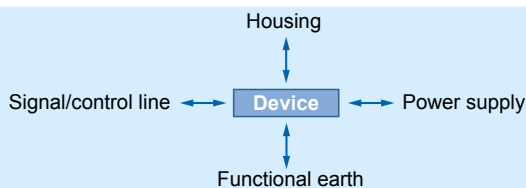

Fig. 1: Interfaces for EMC interference

Regardless of all the testing, sporadic failures of networks occur again and again for no obvious reason. Replacements at the visible fault locations (red error LED) might restore the apparent functionality of the system. However, over the last 15 years, suppliers and operators of industrial networks have come to realise that, in most cases, the visible fault location “red error LED” has nothing to do with the real cause of the problem. The conclusions drawn from this insight – often after a protracted process accompanied by painful losses and failures – can be summed up by “troubleshooting by using diagnostic and service tools” or “permanent network monitoring in the sense of condition monitoring”. Measurements have confirmed that approx. 40% of bus failures are caused by physical transfer quality issues. In addition to installation errors (becoming less frequent nowadays) such failures are obvious consequences of the production environment. Oxidation and corrosion caused by humidity or aggressive media within the contact points, line rupture caused by excessive alternate bending, or simply ageing of components could be identified by measurements as causes of sporadic failures.

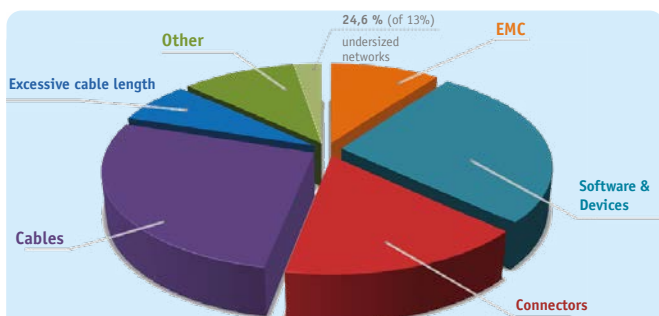

Fig. 2: Excerpt from VORTEX 2022-Report - „Typical Error Sources in Measuring Deployments“

Currently, a new phenomenon has appeared during the search for causes of network failures. It has been noted that data communication issues are becoming more frequent in situations where the system itself does not reveal any weak points.

It was the investigation of shield currents on industrial data lines that prompted the diagnostic approach to take a completely new turn. It soon became clear that the network itself was in perfect condition but was being affected by external influences that are generally referred to as “EMC interference”. Further, extensive measurements, both in the PE/PA system and in the shielding connections of bus lines, revealed an association between high leakage currents (mostly of higher frequency) and network failures.

The following facts and circumstances are presented for explanation and better understanding of the above statements:

- Equipotential bonding (BN) provides protection against contact, and a signal reference potential (protective bonding and functional bonding).
- Operational loads on the bonding system should be as low as possible.
- In the interest of potential bonding, all connections of earthing points should be not low-impedance.
- All devices in a network share the same signal reference earth.
- Networks and fieldbus systems require a concept for continuous shielding with the shields connected at both ends at least.
- There must be no voltage differences within the reference potential.
- A multiple earthing of the negative pole (24V DC power supply) influences the network through leakage current. This might cause device failures.
- When integrating fieldbus networks into existing TN-C systems, the equipotential bonding requires particular attention.

New systems are increasingly installed into older or existing buildings. Experience has shown that system suppliers rely on the specifications provided by the operator, or take a functioning equipotential bonding for granted. They neglect to verify or certify the function or resilience of the existing BN.

## Typical sources of interference

In recent years, many studies have revealed ever increasing loads on equipotential bonding systems due to high-frequency currents. The causes for this increase are quickly identified by the increasing number of variable-speed drives, combined with an increasing degree of automation of machines and systems.

Strong and higher-frequency currents, as generated by frequency inverters for example, are a main cause for EMC interference. The resulting field loads are illustrated in the following figure.

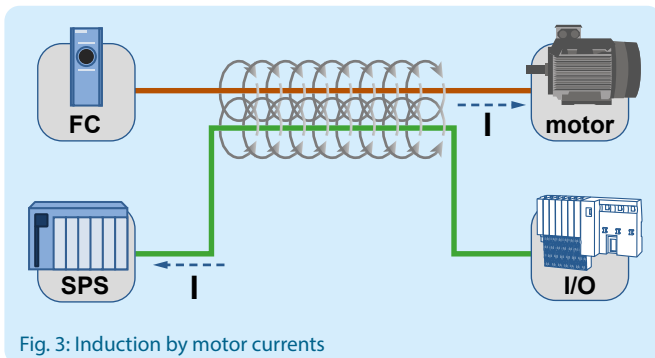

Fig. 3: Induction by motor currents

As soon as an electrical conductor is exposed to a changing magnetic field induction will result. In this instance, this results in a shield current on the network cable.

This problem is widely known and efforts are made to minimise it by shielded lines, by physically separate routing or by spacers in the cable trays.

Other typical sources of interference include power electronics, switching operations (contactors) and equipotential bonding differences. The following principles apply:

- The higher the frequency, the higher the EMC interference
- The more inharmonic the curve shape (rectangular rather than sinus), the higher the EMC interference

There is widespread lack of awareness and attention with regard to another major cause of excessive loads on existing bonding systems (e.g. cable shielding), namely, incorrect or insufficiently dimensioned return current paths. An increasing degree of automation is accompanied by greater demands on the speed and control accuracy of the drives. Ever increasing pulse speeds and the accompanying higher frequencies have resulted in a hugely growing impact of stray capacities on the generation of higher-frequency vagrant currents (for example, in the line leading from a phase to the PE conductor). Particularly in case of asymmetric motor cables this results in an induction on the PE ( $I_{pe}$ ) within the cables. Currents are generated that return to their source (the inverter or the motor cable itself) always following the path with the least impedance. It is not uncommon that such higher-frequency compensating currents flow through shield connections of industrial data cables or through measurement/sensor lines (running parallel to the equipotential bonding or to earth connections) resulting in malfunctions in the connected periphery.

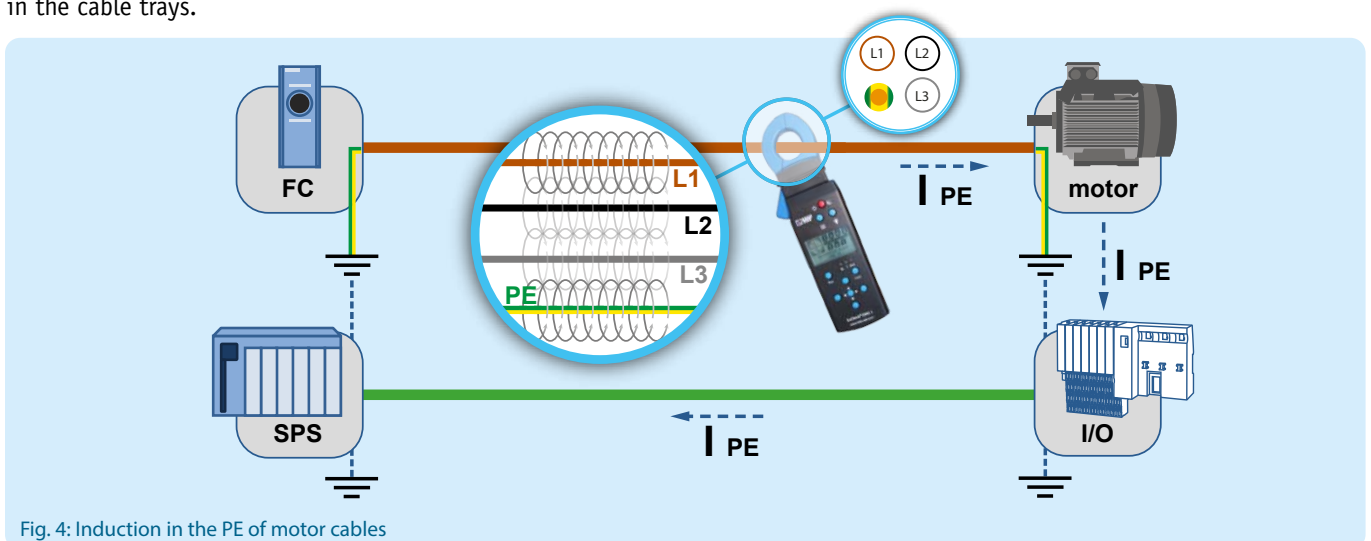

Fig. 4: Induction in the PE of motor cables

A prerequisite to keep the above described problems under control consists in using symmetrical motor lines combined with professional expert installation of an adequate earthing and equipotential bonding system.



## Definitions

### Equipotential bonding (PA)

The objectives of equipotential bonding include the protection of people and animals against electric shock as well as electrical functions such as providing a uniform signal reference potential. A distinction is therefore made between protective bonding and functional bonding.

### Protective bonding PA or BN (bonding network)

This involves establishing electrical connections between conductive parts in order to equalise potentials for the protection of people and animals. (Important aspects include current carrying capacity and ohmic resistance.) This requires copper with a minimum cross-section of 6 mm<sup>2</sup> (DIN VDE 0100-540).

### Functional bonding / earth FE

This involves establishing a uniform, low-impedance signal reference potential for the electronics.

### Protective earth (PE)

Protective earth (PE) protects against excessive body currents and must only carry current in the event of a malfunction.

### Functional earth (FE)

Functional earth (FE) has to ensure error-free operation of electrical systems and devices. The functional earth conductor should not be labelled green/yellow.

### CBN (common bonding network)

A bonding system that provides protective and functional bonding.

### MESH-BN

A meshed equipotential bonding system where all involved conductors are connected to each other and at many points to the CBN.

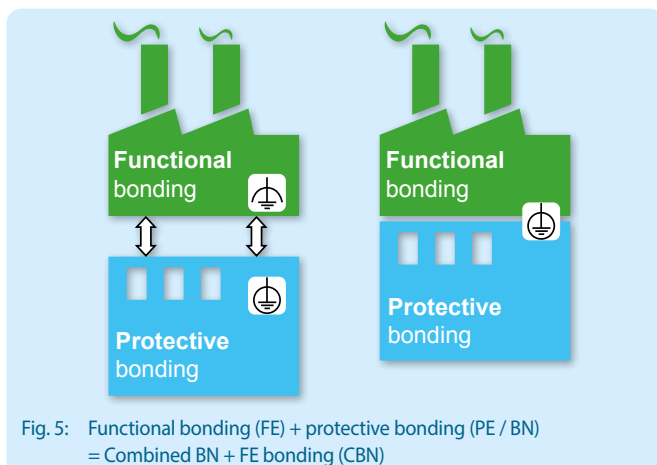

A multitude of standards and guidelines exist on this subject. Some of them repeat or even contradict each other.

### Important standards:

#### Leakage currents VDE 0100-540 / DIN EN 61140 (currents in PE conductors)

The PE conductor should not be used as a conductive path for operating currents in normal operation. When a device is connected and the PE current, under normal operating conditions, is equal to or greater than **10 mA** one of the following constructive measures has to be implemented:

- The PE conductor has to have a minimum cross-section of 10 mm<sup>2</sup> of copper,
- a second protective conductor of equal cross-section has to be provided at a separate terminal on the device.

The maximum current in the PE conductor must not exceed 5% of the outer conductor current.

#### Excerpt from DIN EN 60204-1 Machinery Directive

*„Functional bonding is usually achieved by means of a connection with the PE conductor system (CBN). However, if the level of electrical disturbances in the PE conductor system is not sufficiently low so as to ensure the proper function of the electrical equipment, it may be necessary to connect the functional bonding system to a separate connector for functional grounding ...“*

The question is left open what specific level of electrical disturbances is permissible or low enough for setting up a CBN. The Machinery Directive guideline does not provide a clear answer to this question.

#### Excerpt from DIN VDE 0100-444

*“This type of star-shaped network can be used in smaller installations such as homes, small commercial buildings, etc. and is generally acceptable for equipment that is not interconnected by signal cables or signal lines.“*

This implies that equipotential bonding of the type A (EN50310) with a star structure is not permissible for an electrical system. Electrical equipment is normally connected together by signal cables such as PROFIBUS or PROFINET. In this case, the improved type a (EN50310) with “meshed” star structure is required.

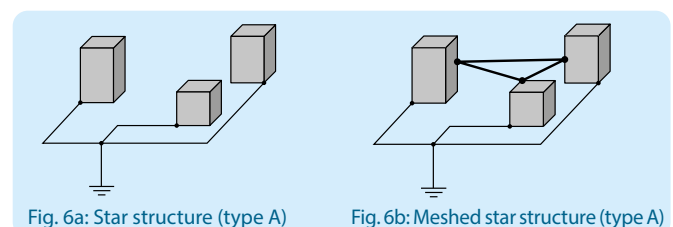

## Reference values

In order to ensure the functional safety of the automation network, the EMC acceptance check – based on measurements – is an essential quality certificate for systems. The objective is to ensure long-term trouble-free operation of all electronic devices in the network by means of targeted exclusion of disruptive factors from the PE/PA system. For this purpose, the “status quo” of EMC loads needs to be established by measurements, evaluated and documented. These measurements (EMC acceptance check) should take place under conditions that closely simulate production and after full completion of the automation technology according to planning specifications.

Measurements are required to determine the following quality parameters:

- EMC loads via the 24 V DC supply
- EMC loads along the industrial data cables (shielding)
- EMC loads in the equipotential bonding system
- EMC loads of the bus modules via the shielding of the analogue encoder lines
- EMC loads via the 230/400 V AC low-voltage distribution system

To carry out the measurements described above a measuring device is required that is capable of displaying a chronological sequence and preferably, a comparison of parallel measuring points.

### EMC quality/resistance:

- Structure/quality of the existing equipotential bonding system
- Ground loop resistances/impedances of the conductors of the protective bonding system
- Ground loop resistances/impedances of the conductors of the functional bonding system
- Resistance/impedance conditions of the existing equipotential bonding system

In order to carry out these measurements the measuring device has to be capable of displaying the quality of the existing bonding system in the kilohertz range as a minimum.

From an economic point of view, it should be possible to perform the measurements during operation of the system.

The need for carrying out the measurements is related to frequent system downtimes that are not caused by communication errors in the industrial data communication but are rather caused by disturbances due to EMC interactions.

In addition to the described measuring tasks for capturing the status quo, it should also be possible to detect sporadic incidents. This requires the use of a measuring device both for temporary and permanent measurement in the sense of condition monitoring.

It is indisputable that the progressive development of power electronic components leads to an increase of interactions in the fieldbus-related environment. The widely publicised integration of the industrial office and production environment and the revolutionary networking of all data strings with each other are resulting in multiplied vulnerabilities to unwanted EMC interactions.

For this reason, the following reference or limit values should be observed during the required measurements:

### Recommended Reference Values

#### Current loads:

- |                             |                                    |
|-----------------------------|------------------------------------|
| ■ Protective conductor (PE) | max. 5% of phase current           |
| ■ Protective bonding system | max. 300 mA<br>(DGVU Regulation 3) |
| ■ Functional bonding        | max. 300 mA                        |
| ■ Motor cable shielding     | max. 300 mA                        |
| ■ Signal cable shielding    | max. 40 mA                         |

#### Resistance/impedance values:

- |                             |                          |
|-----------------------------|--------------------------|
| ■ Protective bonding system | max. 0.3 ohms at 2.2 kHz |
| ■ Functional bonding        | max. 0.3 ohms at 2.2 kHz |
| ■ Motor cable shielding     | max. 0.3 ohms at 2.2 kHz |
| ■ Signal cable shielding    | max. 0.6 ohms at 2.2 kHz |



## Planning for equipotential bonding – Today's technology

As explained at the outset, disturbances of industrial data communication by electromagnetic interference may occur despite all devices and components being in perfect condition. In many cases, however, these interference values are only retroactively determined by measurements. The equipotential bonding system is installed subsequently and then needs to be adapted to the machine and system environment. According to current practice, the electronic components (PLC, drives, remote I/O) are mostly connected to a central earthing point in a star-shaped arrangement (see Fig. 7), regardless whether the bonding system was planned or was installed into a running operation.

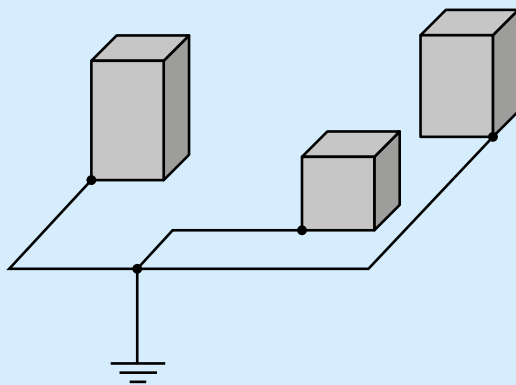

Fig. 7: Star-shaped (type A)

Compared to a strongly meshed bonding system (MESH-BN, see right side) the star-shaped arrangement provides only very few flow paths for compensating currents resulting in heavy loads on the bonding system and the central earthing point. Often long distances need to be bridged to connect devices what results in high installation costs.

The use of insulated conductors is also very common. However, the insulation not only needs to be removed or interrupted manually at each fastening point, such as by contact elements. The option is also lost of improving the equipotential bonding by additional meshing when the conductor comes into contact with metallic objects within the field.

The increasing use of higher-frequency power electronics in industrial automation leads to an increase of electrical loads on devices, components and the network as a whole. As the networking between machines and systems continues to increase, a new type of equipotential bonding systems will be required.

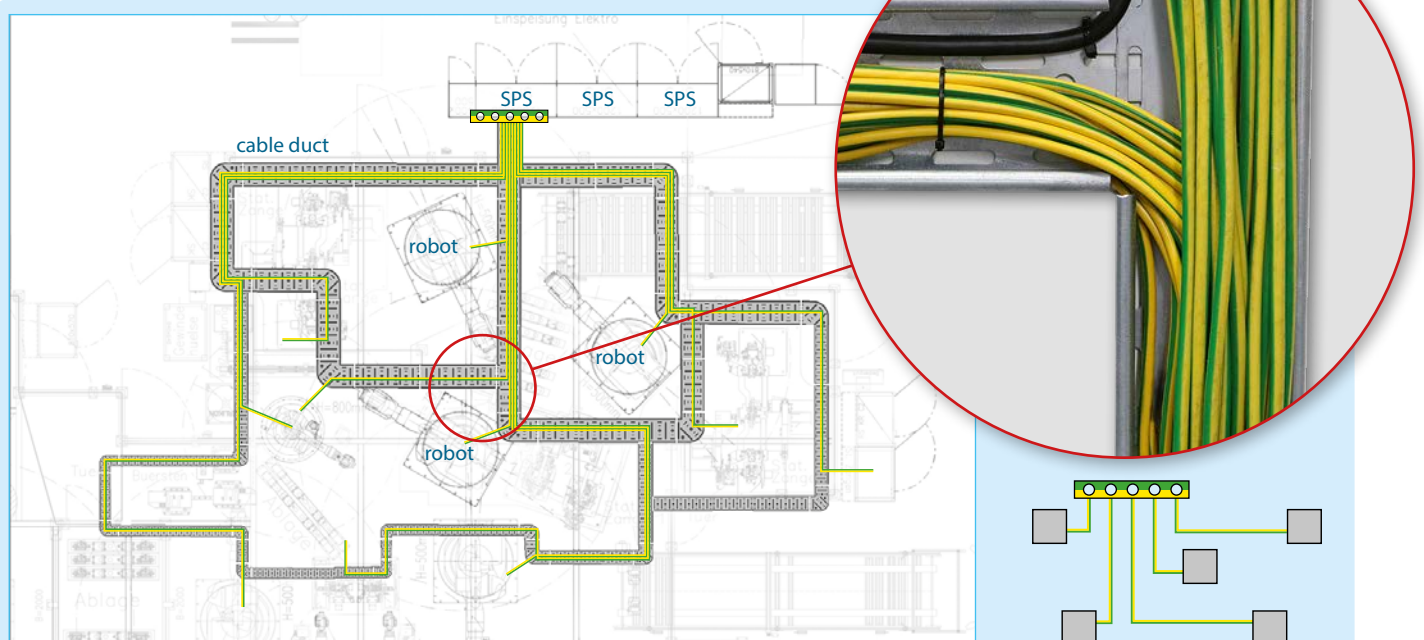
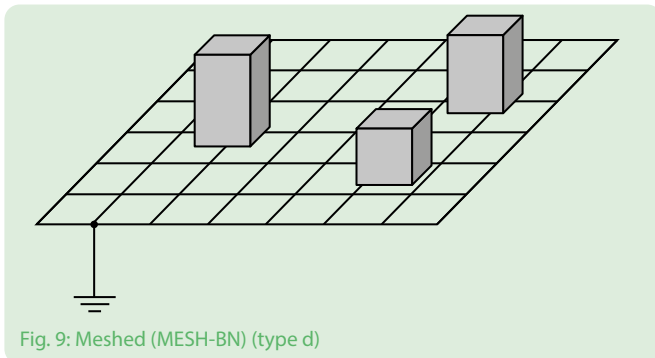

Fig. 8: Conventional installation of bonding system (star)

## Planning for equipotential bonding – Tomorrow’s technology

Measurements have demonstrated that strong meshing in the bonding system reduces the loads on the system itself and on the devices and components. This is achieved by as many short connections as possible between devices and conducting elements – the current is split up and the load is reduced. If bare conductor cables are used, the contact with metallic objects along the connection even increases this effect. The use of field-capable contact elements (**EmClots®**, see page 14) allows the design of efficient conductor paths (short distances, intersections, etc.).



Generally, all devices in the control cabinet need to be arranged and wired as EMC-compatible. This includes all FE/BN connections of electrical equipment being integrated with low impedance and shortest possible distance into the bonding of the electrical cabinets (rear wall and main bonding rail). The same

applies to FE/BN connections of electrical equipment with regard to the equipotential bonding of the machine/system. However, it is recommended to use a minimum of two connections in order to obtain a mesh width of 20 m. In addition, all electrically conductive system components, pipes, trays and channels must be arranged and wired within the machine/system in an EMC-compatible manner in order to achieve a maximum meshing effect.

All switched inductances in the system (contactors, relays, three-phase motors, valves) must be wired with a quenching circuit. All bonding conductors must be implemented as bare (uninsulated), tin-plated, low-impedance strands. Insulated copper conductors are not permitted. The use of suitable fastening elements of the **EmClots®** series (see page 14) will provide an electrically and mechanically stable connection.

The connections on the devices for the functional equipotential bonding (FE) should be connected to the equipotential bonding system (CBN) as shortly as possible and with low-impedance!

By implementing the above mentioned measures, industrial production machines and systems will continue to be designed in an EMC-compliant manner to ensure their maximum trouble-free service life.

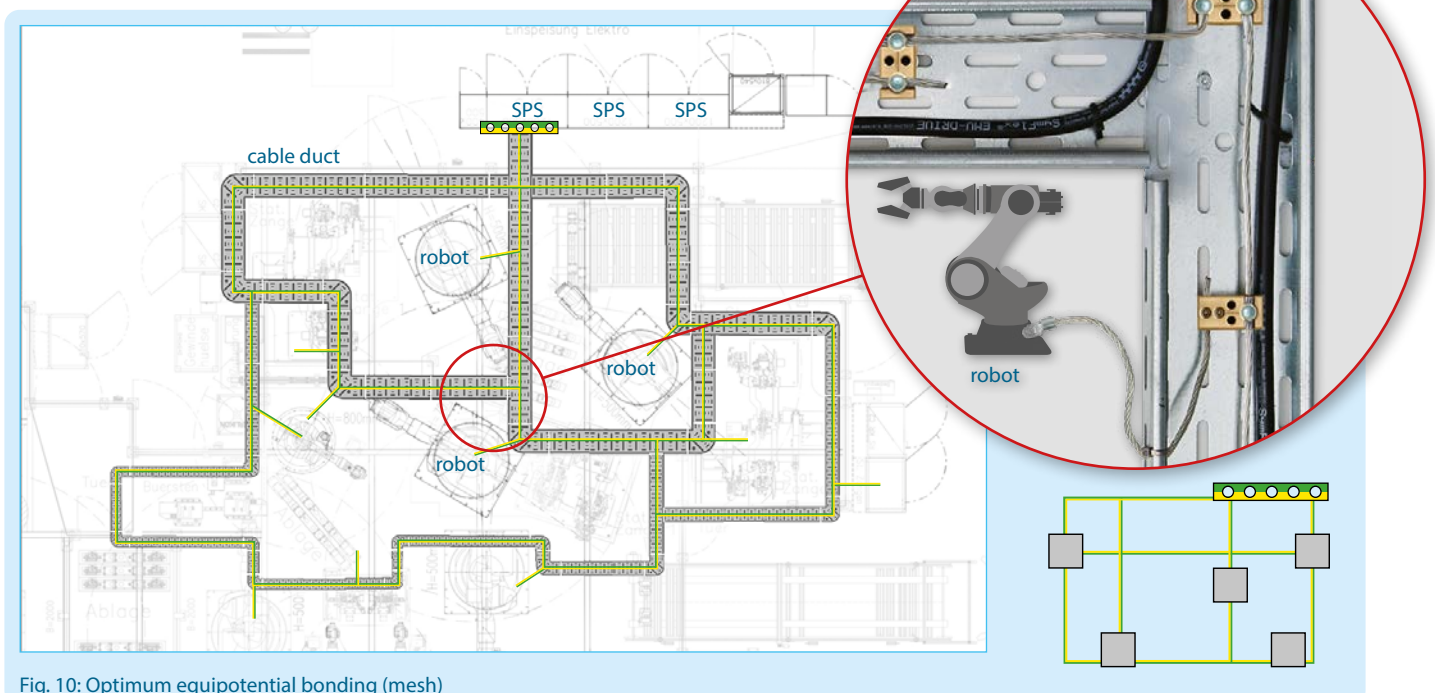

## Conductor cables, tin-plated, extra-fine wire and stranded

### Application

Non-insulated, highly flexible copper cables are especially suitable for the small-loop low-impedance bonding systems required by EN 50310 for machines and installations using higher-frequency drive solutions (inverters). The fine-strand cable structure provides large surfaces for the transfer of higher-frequency currents. Typical interference currents in industrial environments, e.g. due to frequency inverters, are in the range up to 8 kHz, or increasingly up to 20 kHz. Such currents are classified as "higher-frequency" and therefore require low-impedance equipotential bonding. In this range, a current displacement effect (skin effect) occurs.

### Skin effect

The skin effect describes a property of alternating current whereby the electron flow is displaced toward the conductor surface with increasing frequency. In contrast to direct current where the electrons are using the entire cross-section of the conductor, increasing frequencies require a large conductor surface. Beginning with the kHz range, this effect can no longer be neglected. Therefore, larger conductor surfaces are required rather than large cross-sections. Conductor cables made of tin-plated copper strands meet this requirement.

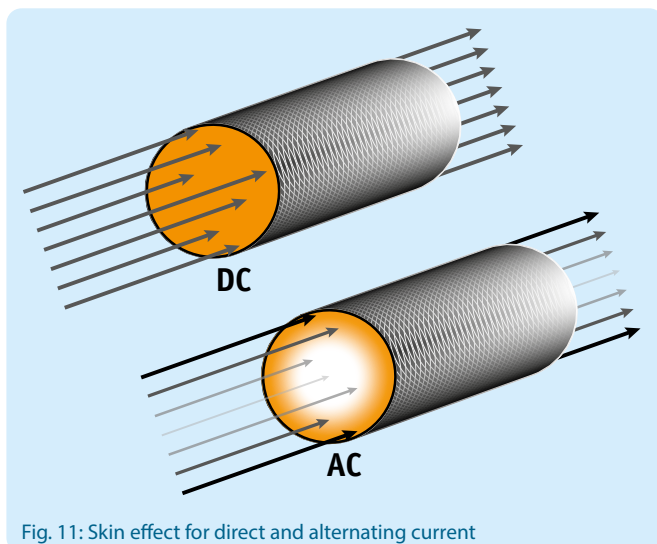

Fig. 11: Skin effect for direct and alternating current

### Function of tin-plated conductor cables

The tin plating acts like an insulation for the individual strands, so that the surface of each individual strand is used effectively. In addition, the surface is protected against corrosion in environments with aggressive media. This has a positive effect on the contact resistance, besides improving visual appearance.

### Notes on the electrochemical series

If two different metals come into contact (galvanic connection) a voltage is generated between them since each metal has a different number of free charge carriers (electrons). Upon contact these electrons migrate toward the "less noble" metal causing it to corrode. To prevent this the voltage between two contacting elements should never exceed 300 mV. This is sufficient to avoid corrosion effectively.

	material	voltage / (V)
base	lithium	- 2,96
	aluminium	- 1,67
	zinc	- 0,76
	chromium	- 0,56
	galvanised steel	- 0,72...-0,53
	iron	- 0,44
	nickel	- 0,25
	mild steel	- 0,48...-0,21
	cast iron	- 0,42...-0,18
	tin	- 0,14
noble	lead	- 0,13
	hydrogen	± 0,0 (ref.)
	brass	+ 0,05 ... + 0,26
	copper	+ 0,345
	bronze	+ 0,03...+0,36
	chromium nickel	- 0,05...+0,75
	gold	+ 1,38

As shown in the sample calculation under "Recommendation", terminal points have significantly lower clamping voltages toward tin or copper. Tin-plated conductor cables also have advantages over bare conductor cables since their clamping voltage is also significantly reduced.

### RECOMMENDATION galvanic connection

#### Sample calculation

#### For tin-plated conductor

- ...on zinc-plated shield clamp  
 $-0.14 \text{ V} - (-0.76 \text{ V}) = 0.62 \text{ V} !$
- ...on brass-plated clamping element (e.g. EmClots®)  
 $-0.14 \text{ V} - 0.105 \text{ V} = 0.245 \text{ V}$

#### For copper conductor

- ...on zinc-plated shield clamp  
 $+0.345 \text{ V} - (-0.76 \text{ V}) = 1.105 \text{ V} !$
- ...on brass-plated clamping element (e.g. EmClots®)  
 $+0.345 \text{ V} - (+0.105 \text{ V}) = 0.24 \text{ V}$

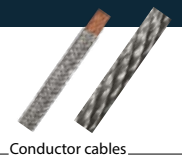

Conductor cables

### Conductor structure to DIN 46440

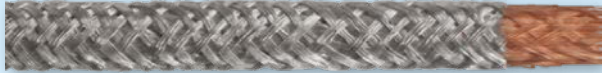

#### Structure (tin-plated and extra-fine wire)

- Cross-section: 0,5 mm<sup>2</sup> - 120 mm<sup>2</sup>
- Material: bare, highly flexible stranded copper cable, tin-plated shielding according to DIN 46440
- Surface: tin-plated

**Multi-frequency combination**

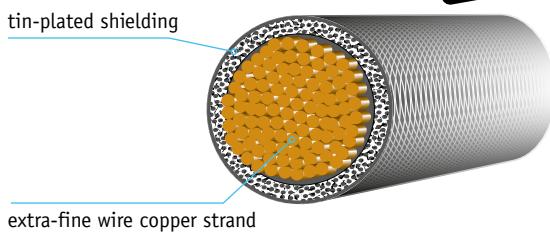

### Multi-frequency conductor cable

Electromagnetic interference in industrial systems comes in many guises. This calls for flexibility of components for installing an equipotential bonding system in order to be equipped for the different possible scenarios of electromagnetic interference. The multi-frequency conductor cable by Indu-Sol therefore combines the properties of both a conventional conductor cable and a high-frequency cable.

The structure of the inner core corresponds to a bare, extra-fine wire conductor cable "class 7". This provides the necessary cross-section for dissipating low-frequency currents. Many years of Indu-Sol experience in measurement technology have demonstrated that in practice the shielding of data cables often has a lower impedance than the bonding system. Therefore the data cables are being used by so-called "vagrant" currents as a return current path. For this reason, the core of the multi-frequency combination conductor cable is sheathed by a higher-frequency-capable waveguide that corresponds in structure to the shielding mesh of a high-frequency cable. This enables the conductor cable to dissipate various types of current and to keep them away from the data cables.

### Conductor structure to VDE 0295 class 2



#### Structure (stranded)

- Cross-section: 0.5 mm<sup>2</sup> - 120 mm<sup>2</sup>
- Material: Cu-ETP wire corresponding to DIN EN 13602
- Surface: tin-plated

**Stiff installation**

### Conductor structure to VDE 0295 class 5

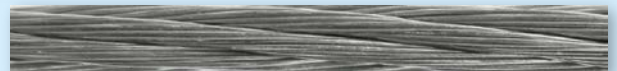

#### Structure (fine-wire)

- Cross-section: 0.14 mm<sup>2</sup> - 120 mm<sup>2</sup>
- Material: Cu-ETP 1 wire, soft-annealed, corresponding to DIN EN 13602
- Surface: tin-plated

**Flexible installation**

### Conductor structure to VDE 0295 class 7(\*)



#### Structure (extra-fine wire)

- Cross-section: 0.14 mm<sup>2</sup> - 120 mm<sup>2</sup>
- Material: Cu-ETP 1 wire, soft-annealed, corresponding to DIN EN 13602
- Surface: tin-plated
- Insulation: optionally, extra-soft plastic sheathing in diff. colours made of soft PVC, to VDE 0207, 0281

**Highly-flexible installation**  
(in insulated version for drag chains)

(\*) corresponds to class 6, row 6

### Special conductor structure class 8(\*)



#### Structure (tin-plated and extra-fine wire)

- Cross-section: 4 mm<sup>2</sup> - 25 mm<sup>2</sup>
- Material: copper cable, tinned and wrapped round with fleece
- Surface: tin-plated
- Lagging: special soft-PVC (very good resistance to oil, chemicals, cold and heat (-40°C till 125°C))

**UL version available**  
(drag chain, robots)

(\*) corresponds to class 6, row 6

## EMClots® fastening elements – stable and conductive

### Planning for equipotential bonding with foresight

The use of **EMClots®** significantly facilitates the implementation of a distributed equipotential bonding system. A variety of components can be used for connecting, fastening and branching of bare conductor cables of extra-fine wire and stranded type. Undefined interference currents are thus prevented and uniform equipotential bonding is implemented even in long production lines. **EMClots®** are ideally suited for implementing small-loop low-impedance bonding systems for machines and installations using higher-frequency drive solutions (inverters) as required by EN 50310.

### Why MESH-BN?

When using a combined protective and functional bonding system (CBN / Common Bonding Network) it must be ensured that no excessive compensating currents (reference value: max. 40 mA) will be dissipated via the shielding of data and signal lines.

For buildings with IT installations, including industrial networks such as PROFIBUS and PROFINET, the DIN EN 50310 standard recommends a meshed bonding system (MESH-BN). This provides a multitude of paths for compensating currents. The meshing results in a parallel connection of the line impedances what lowers the overall impedance of the bonding system.

The tin-plated conductor cable in combination with **EMClots®** terminals allows the implementation of a meshed bonding system with minimum effort. Continuous conductor cables can be tapped by means of **EMClots®** without separating any connections.



application example: EMClots® Junction V2

### Highlights

- Significant material savings for conductors
- Significantly less installation time
- Much higher EMC resistance



application example: EMClots® Connector V2 GRID

Due to the conductive structure of the terminal, metallic system components such as cable trays and pipelines are automatically integrated into the bonding system. Necessary wiring is reduced significantly.

### Fastening of EMClots®

**EMClots®** terminals are fastened to e.g. trays, profiles or other conductive system components. On cable trays the installation is also possible on the inside or outside of the side panel (sees Fig. lower left). An installation guide is available in the download section of the website ([www.indu-sol.com](http://www.indu-sol.com)).

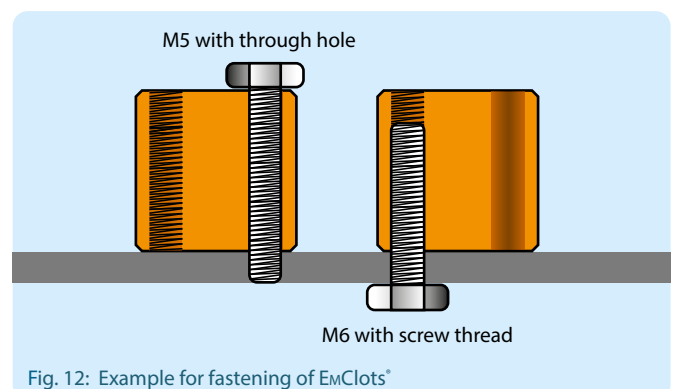

Fig. 12: Example for fastening of EMClots®



EmClots®

## EmClots® Junction

### EmClots® Junction V2

- **EmClots Junction V2** elements are suitable for stranded or extra-fine wire conductor cables of 4 to 16 mm<sup>2</sup> (stubs up to 10 mm<sup>2</sup>) or 25 to 35 mm<sup>2</sup> (stubs up to 16 mm<sup>2</sup>).
- They are used to connect three conductor cables or to create a stub.
- They are mounted to cable trays, cross beams or other conductive system components.
- Mounting screws:  
M 6 (screw thread),  
M5 (through hole)



### EmClots® Junction V2 GRID

- **EmClots® Junction V2 GRID** are for connections of several conductors of 4 to 16 mm<sup>2</sup>.
- Sie werden an Gitterstäben mit max. Ø 5 mm montiert



### EmClots® Connector V2 GRID

- **EmClots® Connector V2 GRID** are for connections of several conductors of 4 to 16 mm<sup>2</sup>.
- They will be stuck on bars mounted with max. Ø 5 mm



## Highlights

- RoHS 2 (2011/65/EU) compliant
- Electrical transitions DIN EN 60512-2-2
- Mechanical stability: DIN EN 60721-3-3:1995
- Certified climate test: extended ambient temperature

## EmClots® Connector

### EmClots® Connector V2

- **EmClots Connector V2** elements are suitable for stranded or extra-fine wire conductor cables of 4 to 16 mm<sup>2</sup> or 25 to 35 mm<sup>2</sup>.
- They are used to connect two conductor cables.
- They are mounted to cable trays, cross beams or other conductive system components.
- Mounting screws:  
M 6 (screw thread),  
M5 (through hole)



## EmClots® Fastening

### EmClots® Fastening V2

- **EmClots Fastening V2** elements are suitable for stranded or extra-fine wire conductor cables of 4 to 16 mm<sup>2</sup> or 25 to 35 mm<sup>2</sup>.
- They are used to fasten a conductor cable.
- They are mounted to cable trays, cross beams or other conductive system components.
- Mounting screws:  
M 6 (screw thread),  
M5 (through hole)





## EmClip® shield terminal system – direct and with large contact area

### EmClip® system

Fastening elements for cable shielding help you to dissipate interference and compensating currents in a clean and defined manner. The components can be easily mounted on the cables without any tools and provide optimised cable shielding contact. No need to readjust the spring tension – the shielding is under permanent, constant pressure.

creates flexibility and variety of mounting options while the number of basic components is reduced.

### Modular assembly system

By means of the modular assembly system the shield clamps are plugged in during installation to connect with the clips for top-hat rail, direct mounting or bus bar. This system in-

Depending on range of application the shield terminals (SK) have the following properties:

- |                                | Fastening type |
|--------------------------------|----------------|
| ■ Direct mounting .....        | D              |
| ■ Bus bar .....                | S              |
| ■ Top-hat rail .....           | H              |
| ■ incl. strain relief .....    | Z              |
| ■ Double shield terminal ..... | Duo            |

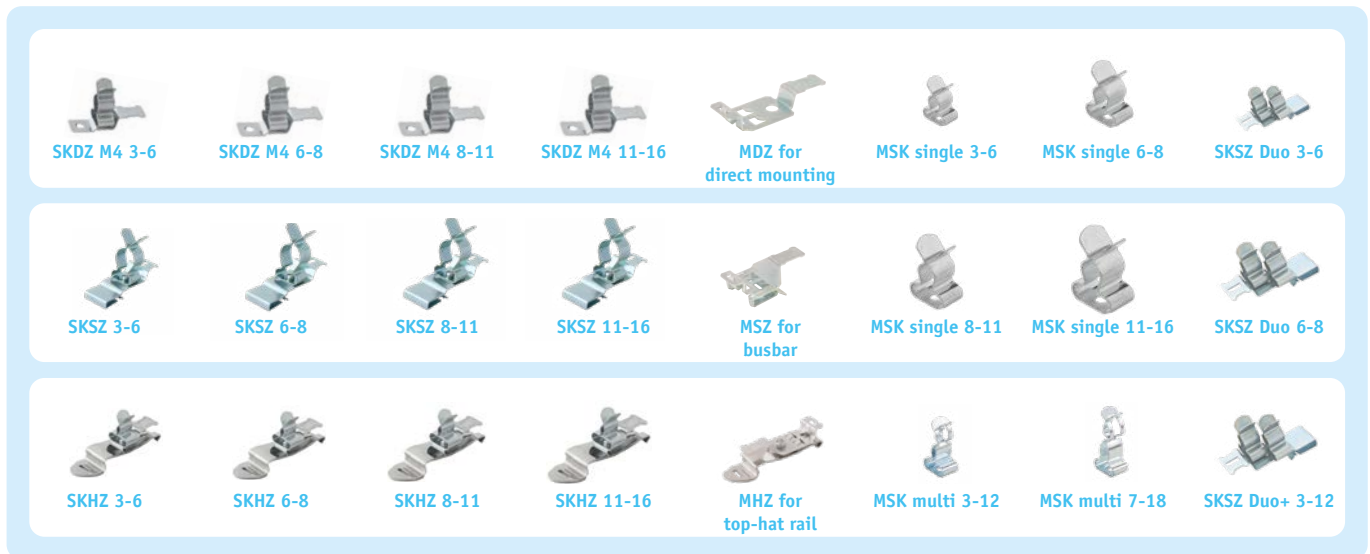

### EmFlex Strippingtool

The EmFlex stripping tool is used for flexible and precise removal of cable insulation. It is particularly small and compact and ideally suited for use in limited space conditions. The spring-loaded plastic crawls automatically adapt to the cable cross-section. The cutter is swivel-mounted and adjustable for circular and longitudinal cuts and for various cutting depths.



### EMC STARTERBOX

This case for any EMC eventuality includes fastening for conductor cables and copper cables as well as shield clamps. It will help you to discharge parasitic currents and compensating currents and achieve an equipotential bonding of low impedance. The components can simply be mounted on cables without using tools and provide for an optimal bonding of cable shield. The **EMC STARTERBOX** is available in the versions "standard" and "mixed" (see page 31).



### Highlights

- Variable cutting depth (from 0.8 to 2.5 mm)
- Removing the insulation at any point along the cable
- Suitable for very hard insulations and high stripping lengths



## PROFINET and PROFIBUS cable +FE (functional earth)

PB- / PN cable +FE

### Description

The cables of the +FE series were developed to allow line routing in heavily "EMC-polluted" environments. The shielding relief conductor that surrounds the data cable has two important functions: In both cases, the shield relief conductor must be connected on both sides with an additional contact (e.g. EMClip shield terminal system, see page 16) in front of the respective unit.

### Function 1 (see Fig. 15)

In the event of heavy exposure to electromagnetic fields it acts like an additional shield. It relieves the actual shield of excessive shield currents and of their negative impact on signal quality and on the functional safety of devices.

### Function 2 (see Fig. 16)

Conventional bonding systems (BN) generally have a star-shaped structure (type A) and are therefore unsuitable for the purpose of functional bonding (FE). The shielding relief conductor has the function of improving the bonding system (improved type A).

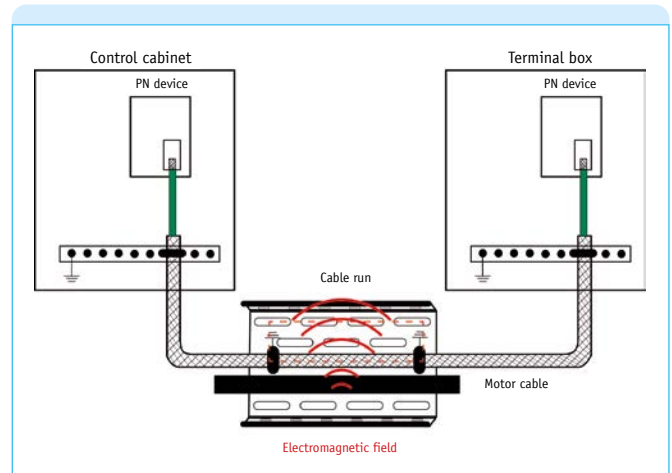

Fig. 14: Function 1 – Additional shield in environment with heavy field

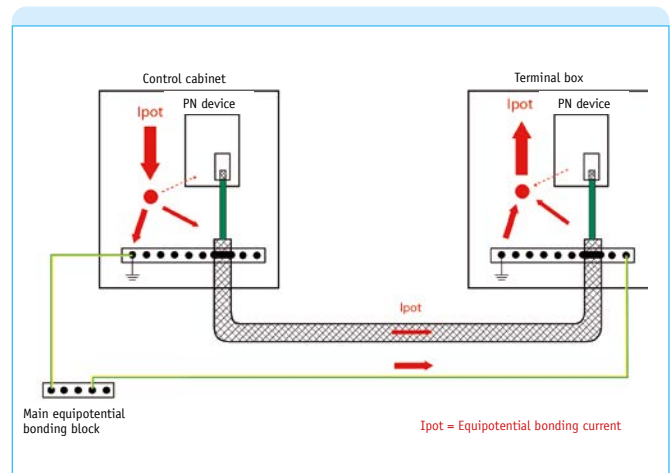

Fig. 15: Function 2 – Additional functional bonding

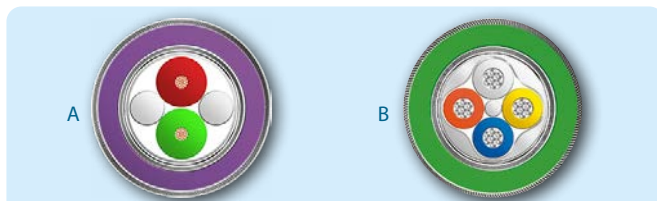
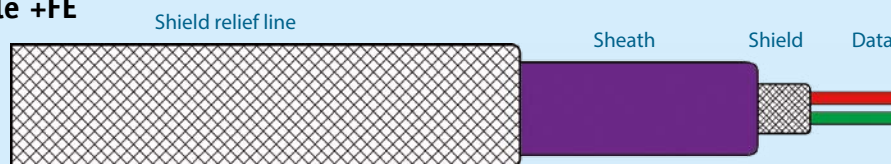

Fig. 13: Cross-sections PROFIBUS cable +FE (A), PROFINET cable +FE (B)

### PROFIBUS cable +FE



#### Shield relief line

- Feature 1: Additional shield in an EMC contaminated environment
- Feature 2: Additional functional equipotential bonding

### PROFINET cable +FE

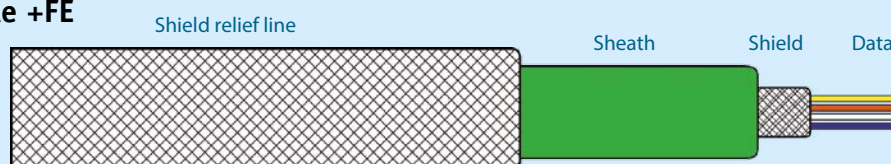

## Symmetrical motor cable SymFlex® EMV-DRIVE / +FE

The objective of an EMC-compatible design of automation systems is to minimise the impact of potential sources of interference. When high-frequency consumers are being connected, it is observed that capacitive coupling leads to unwanted currents in the PE of the motor line. These currents, generally referred to as leakage currents, are being dissipated into the equipotential bonding system and it is not uncommon that they will take the low-impedance path via the data line shielding.

To compensate these undesirable currents right at their origin it is suggested to use the special symmetrical motor cable **SymFlex® EMV-DRIVE**.

### Highlights

- Minimising unwanted currents
- Optimised for frequency-controlled drives
- Low working capacitance/inductance guaranteeing minimum electromagnetic emissions
- Symmetrical arrangement of cable cores
- Special CU braid and additional electrostatic shielding

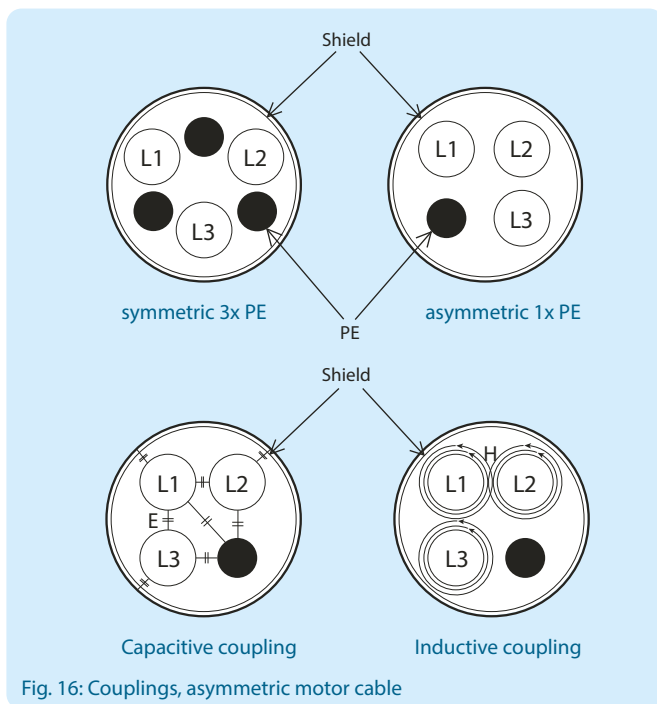

Fig. 16: Couplings, asymmetric motor cable

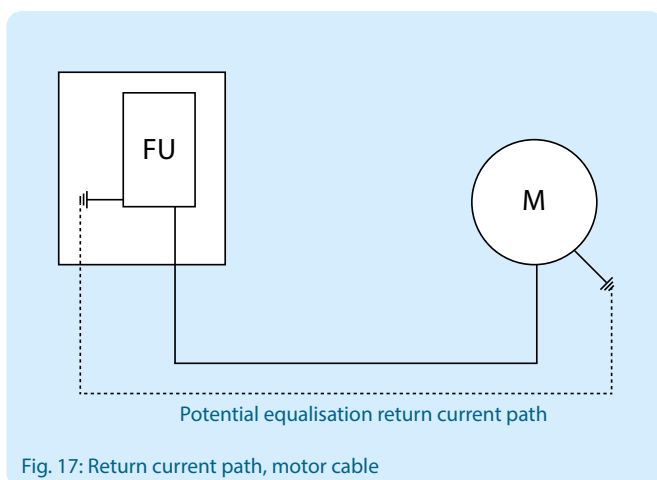

Fig. 17: Return current path, motor cable

### Function

The motor cables of the **SymFlex®** series have been optimised for use in frequency-controlled drives. As the cable is enclosed by a combination of braided and foil shield (100% covering) a low working capacitance and inductance is assured what guarantees minimum electromagnetic emissions to neighbouring electronic equipment circuits.

To minimise the impact of electromagnetic fields to permissible levels the cables are provided with a special CU braid and additional electrostatic shielding.

### Application

Motor cables of type 2YSLCYK-3JB (labelling according to the standard) are suitable for fixed installation in dry, humid and wet rooms, for outdoor use, and for flexible use without additional mechanical stresses.

We specially recommend the symmetrical motor cable for high drive densities, long cable lengths (> 20 m), high pulse frequencies of frequency inverters or controllers and for a wide range of sensitive electronic automation equipment in the environs of the drives.



SymFlex® EMV-DRIVE +FE

## Minimising shield currents

The inductive currents and part of the capacitive currents coupled into the PE and shielding of motor cables find their way between inverter and motor through the bonding system. Under unfavourable circumstances (long cables, high frequency, poor cable symmetry) up to 10% of the motor phase current will be coupled into the PE. It is not uncommon that such higher-frequency compensating currents flow through shield connections of bus lines or through measurement lines running parallel to the PE or to the earth connection resulting in malfunctions in the connected periphery.

To minimise such currents right at their point of origin (source) symmetrically designed motor cables of the **SymFlex®** series are used. The resulting lower working capacitance/inductance reduces the current coupled into the PE (interference current) by 60%. The system-wide use of motor cables of the type **SymFlex® EMV-DRIVE** will significantly improve electromagnetic compatibility of the entire system including the factory hall without higher costs of purchase and installation.

## Prevent bearing currents!

For installation of frequency-controlled three-phase drives, renowned inverter manufacturers recommend using symmetrical multi-core motor cables exclusively. The clearly defined purpose is to prevent or minimise bearing currents in order to prevent damage to bearing rings by spark erosion from high-frequency current pulses.

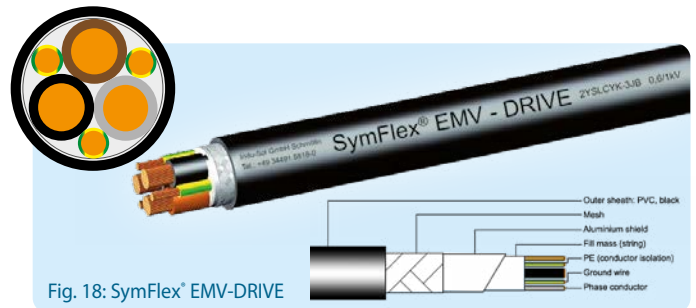

Fig. 18: SymFlex® EMV-DRIVE

## Structure

Copper strand, bare, to VDE 0295, class 5, resp. IEC 60228 cl. 5, wire insulation 2 Y to VDE 0207, wires stranded in layers with filler, insulating foil, aluminium foil shielding, CU mesh, galvanised (approx. 80% coverage), PVC jacket insulation. Core colours: 3 x green/yellow, grey, brown, black.

## Characteristics

### Electrical

- Nominal voltage: 600/1000 V
- Testing voltage: 4000 V
- Insulation resistance: > 5 GOhm/km
- Coupling resistance: max. 250 Ohm/km
- Working capacitance, depending on cross-section:
  - Core/core: 70 - 250 nF/km
  - Core/shield: 110 - 410 nF/km
- Inductance
  - depending on cross-section: 0,25 - 0,38 mH/km

### Mechanical and thermal properties

- Bending radii:
  - Moved occasionally: 10-20 x cable diameter
  - Fixed installation: 5-10 x cable diameter
- Temperature range:
  - Moved occasionally: +5 to +70 °C
  - Fixed installation: -40 to +70 °C

- Cross-sections up to 240 mm<sup>2</sup>
- Halogen-free
- Fire propagation
- UL-compliant
- PUR jacket
- drag chain capable

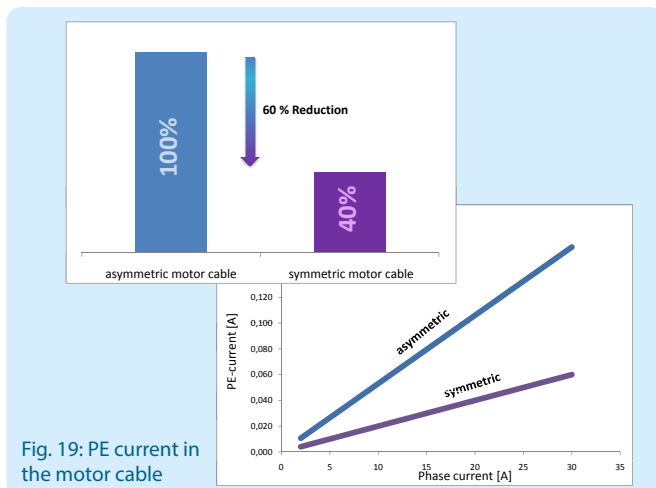

Fig. 19: PE current in the motor cable

## RECOMMENDATION norm identification

- 2Y** Insulation/jacket of thermoplastic polyethylene (PE)
- SL** Control cable
- C** Shield of braided CU and aluminium shield foil
- YK** Outer sheath of polyvinyl chloride (PVC), black
- J** Cable with green and yellow core
- B** Ethylene/propylene rubber



EmCheck® LSMZ I

## Leakage current measuring clamp EmCheck® LSMZ I

### Measuring and avoiding shield currents

Sporadic interferences in the industrial data communication are mostly caused by compensating currents produced by high-frequency shield currents. Faults in the network technology are often searched directly in the network and mistrust in the arises. In consideration of the compensating currents of the shield of the data cable, it becomes clear that the network is not the reason, but represents the “aggrieved party”. It is now essential to detect the initiator and to take the accordant countermeasures.

The leakage current clamp **EmCheck® LSMZ I** is especially designed for the measuring of leakage and shield currents in the frequency band of 50/60 Hz as well as 5 Hz – 1 kHz. The adjustable measuring range is arranged in levels from 30  $\mu$ A - 100 A whereupon the lower range is of special interest for the shield current measurement of the data cable.

Furthermore, the leakage current clamp **EmCheck® LSMZ I** is the ideal measuring tool to detect insulation faults and unintentional interruptions of FI-safety switches caused by leakage. The leakage current clamp offers all functions of a multiple measuring clamp.

### Highlights

- Measuring leakage and shielding currents
- Adjustable measuring range
- Localising insulation faults and unwanted shutdown of earth-leakage circuit breakers
- All the features of a multimeter clamp
- Continuous measurements by hold functions (e.g. peak current)
- True RMS measurement function

### Configuration and function

The **EmCheck® LSMZ I** is characterized by a large opening (2,8 cm) for the cable to led through so that a comfortable measurement is also possible in unfavorable installation situations. Through the holding function it is possible to perform permanent measurements such as maximum currents.

### Guideline:

By experience of Indu-Sol GmbH a shield current of <40 mA was proven justifiable independently from the machine specifications. A statement according to the level should be made in connection with the adjusted frequency range to carry out the correct actions in terms of a reduction of shield currents.

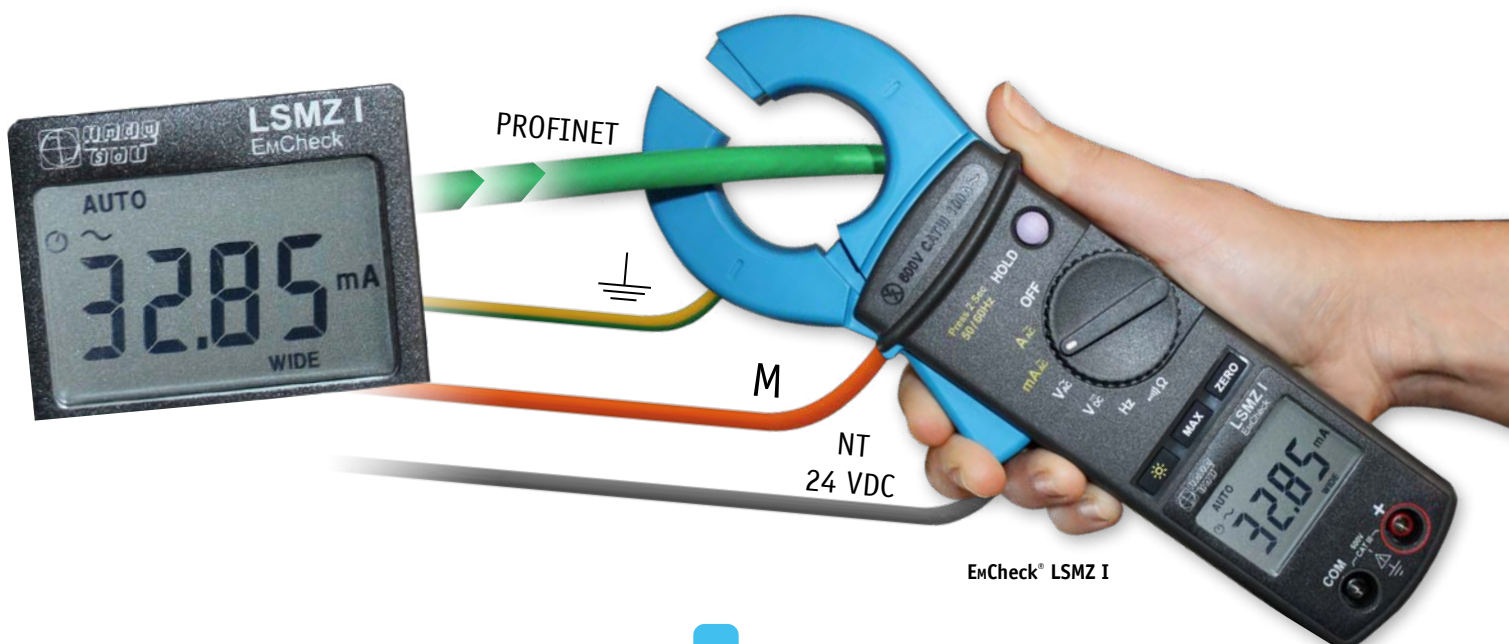



EmCheck® MWMZ II

## Mesh resistance measuring clamp EmCheck® MWMZ II

### Determination of loop resistances

From the perspective of automation technology the function of the equipotential bonding is not put into question because the functionality is presumed and the points of contact are mostly seen in the low voltage system. However in the meantime it was exposed that a secure and solid working communication network, including the bus system, is connected to the function of the equipotential bonding. Straying currents and currents of higher frequency which are often caused by frequency converters, mostly use the shield of our data cable as return current flow instead of the intended equipotential bonding system.

The explanation is simple: ***“Discharge currents of higher frequency do not use the way of lower ohmic resistance but always the way with lower impedance...!”***

Just relying on gut feeling, or making intuitive statements about the quality and functionality of existing shielding and earthing measures is rarely a good idea. The only way to ensure good equipotential bonding is proof by measurement in compliance with DIN EN 50310. The mesh resistance measuring clamp **EmCheck® MWMZ II** is the right tool for this purpose.

### Reference values:

The shield loop resistance of data cables (for example: field-bus cables) should have a maximum impedance value of 0,6 Ohm. PE/PA loop resistances should be in the range of an

### Highlights

- Measuring of earth loop resistance and earth loop inductivity
- Measuring the screen loop impedance of the data line
- Display of contact voltage
- Alert when detecting a dangerous voltage
- Recording of up to 300 measurements incl. time stamp
- Easy handling to keep the clamp open
- Good visibility of all displayed data via OLED display

approximated impedance value of 0,3 Ohm.

### Mode of functioning and operation

The clamp consists of two coils. The first coil induces a voltage with a defined frequency 2,083 Hz. The second coil measures the current induced by coil one in the set frequency range. The ratio of these two values is used to determine and display the alternating current resistance (impedance) – and if necessary additionally calculated for 50, 60, 128 Hz. The measurement is made without any interruption and can also be carried on conductors which already carry currents during their normal operation.

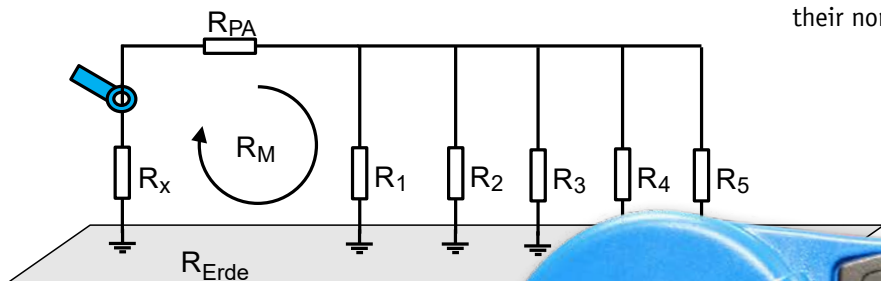

The total resistance of each mesh will be minimized by a higher amount of meshes generated in the potential equalization.

EmClots® Junction V2

EmCheck® MWMZ II



EmCheck® ISMZ I

## Intelligent current measuring clamp EmCheck® ISMZ I

There are undesirable interactions between power supply and control technology in complex industrial systems that might cause errors in control engineering. These interferences often arise from communication failures between components. Since the failure causes are usually hard to find, a mobile detection system in the form of a current clamp for line-based parasitic currents achieves significant savings of installation expenses and in service department.

The Intelligent current measuring clamp **EmCheck® ISMZ I** is a mobile tool for detecting line-based parasitic currents in industrial plants. It detects values by its own up to a frequency of 20 kHz, evaluates and records data.

The integrated intelligence is innovative. It allows first surveys and hence first estimations of EMC susceptibility of plants without requiring special tools.

Furthermore, the intelligent current measuring clamp **EmCheck® ISMZ I** is applicable in an environment with heavy interferences.

### Highlights

- Measuring leakage, shielding and interference currents
- Data recorded on internal memory for a period of up to 14 days
- Compact, portable, battery-operated current clamp
- Easy and intuitive operation
- Independent capture, evaluation and recording of data
- Easy display and menu functions to assess existing current levels for a line
- Data evaluation by dedicated software on a standard PC

A large variety of malfunctions can be adequately analysed by the captured measuring data. Therefore, the need to use more sophisticated devices and to call in a qualified expert can be reduced to a small number of incidents.

### EmCheck® View

**EmCheck® View** is the free operating software for the **Intelligent Current Measuring Clamp (ISMZ I)**. It displays the measurement data on screen for convenient evaluation.

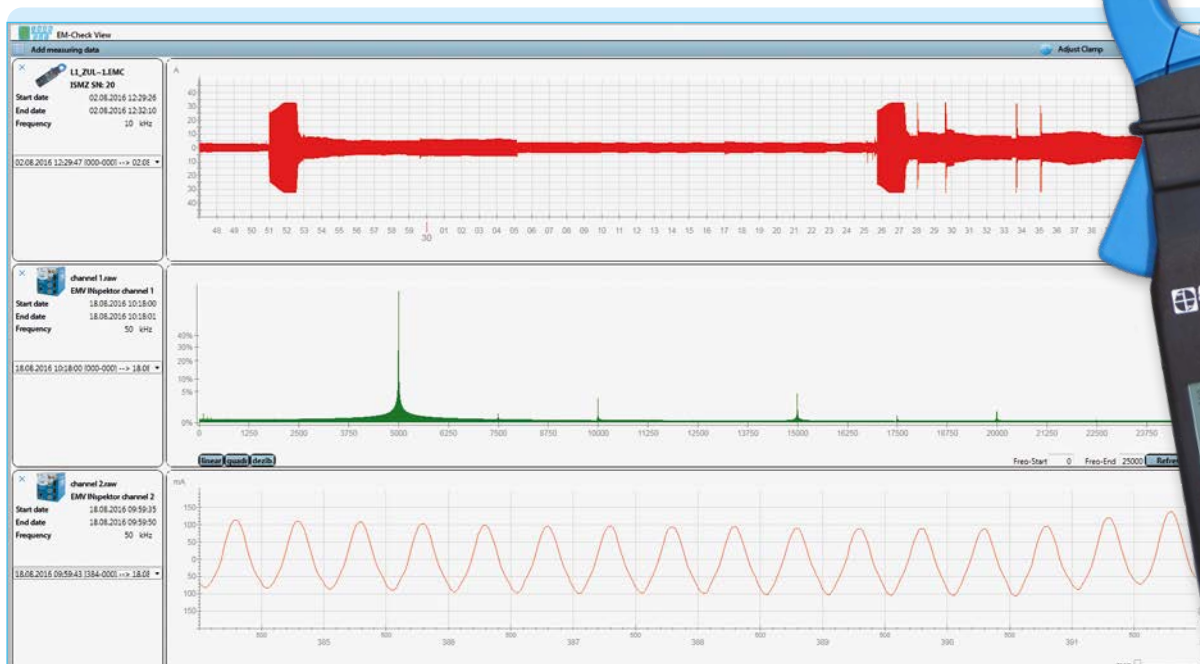

Fig. 20: Display of ISMZ measurement data by EmCheck® View





EMV-INSpektor® V2

## EMV-INSpektor® V2

With an increasing automation level of industrial productions the power density rises and thus the risk of disturbances by electromagnetic interferences. In this context interference currents occur along fieldbus cables, encoder lines, the routings of power supply and equipotential bonding systems.

**EMV-INSpektor® V2** is a special measuring and analysing tool to record temporarily or permanently electromagnetic interferences. It allows connecting up to four current transformers, which measured values were recorded, evaluated and compared separately. Depending on the line type different quality parameters can be configured.

Thereby it provides a specific evaluation and monitoring of each measuring channel in the interest of Condition Monitoring. The sector of industrial automation obtains a smart tool for comprehensive fieldbus analyses by the **EMV-INSpektor® V2**.

### Measuring rudiments:

- EMC interferences along the data cables
- EMC interferences via the 24 VDC power supply
- EMC interferences via the 230/400 VAC low-voltage distribution system
- EMC interferences in the equipotential bonding system
- EMC interferences via the transmitter lines

### Highlights

- Measuring leakage, shielding and interference currents
- Parallel inspections of multiple potentially disturbed sections
- Permanent analysis and monitoring (Condition Monitoring) with PROmanage® NT
- Data comparison of each input source
- Specific status evaluation and alerting
- Visual display of interferences via web interface
- Export of measurements on USB stick or via LAN interface
- Configuration of device software via web interface

### Application

The **EMV-INSpektor® V2** provides an automated, contact- and interruption-free long-term inspection. Up to four channels can be connected, measured and analyzed.

On all four channels the current course and the spectrum are captured up to a frequency of 50 kHz per channel. This makes it possible for example to detect if there is a link between fieldbus (PROFINET) malfunctions and PE/PA currents. The additional frequency data from the spectrum provide clues regarding the possible cause of the fault. Frequency components in the lower kHz range point to pulse frequencies of frequency inverters.

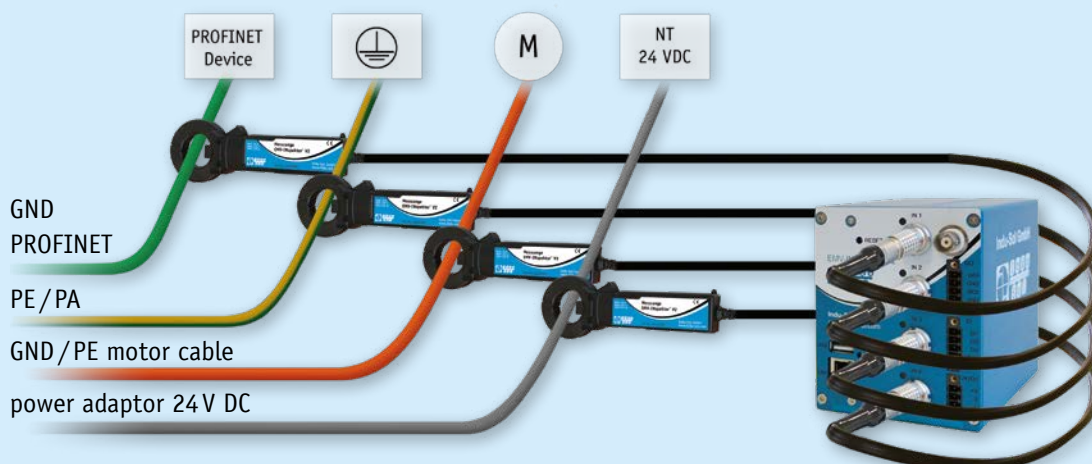

Fig. 21: Application example EMV-INSpektor® V2



## Evaluation EmCheck® ISMZ I and EMV-INspektor® V2

In modern industrial facilities switching power supplies, drive solutions and similar equipment influence the quality of the network. Due to these electric interdependencies measuring devices that only capture currents at a specific moment often provide inaccurate results. Therefore, precise current measurement is not as trivial as it might appear at first glance.

### Effective value – RMS (Root Mean Square)

For the measurement of alternating current the root mean square of the alternating value is normally used which is the effective value. The effective value of an alternating current is equivalent to the energy that a direct current would present at a resistive load. However, this measurement is only accurate in case of a pure sinus current. Many of today's consumers, however, deviate from an ideal sinus shape.

### Current course with amplitude

To analyse a current course it is important to know the amplitudes of the current. With the **EmCheck® ISMZ I** and the **EMV-INspektor® V2** currents can be scanned at 40 kHz or 50 kHz. For each scan point you also obtain the amplitude in order to realise a meaningful analysis.

The current data recorded in the devices can be easily accessed with the free **EmCheck® View** software.

Interference pulses caused by switching operations at the contactor cannot be detected by conventional current measurements. They are too brief and also deviate significantly from sinus shape.

### Conventional measurement

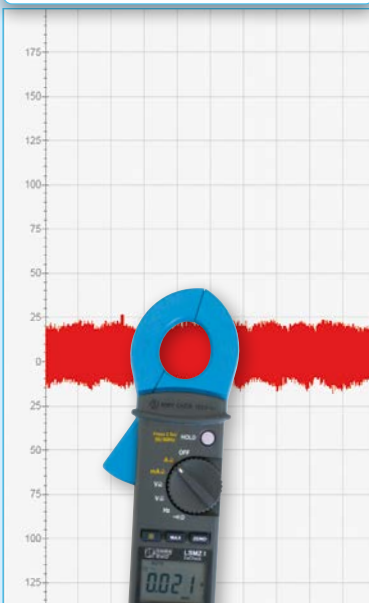

21 mA  
RMS



Conventional effective-value measurement is very inaccurate for this signal shape.

### Intelligent capture of sporadic interference peaks

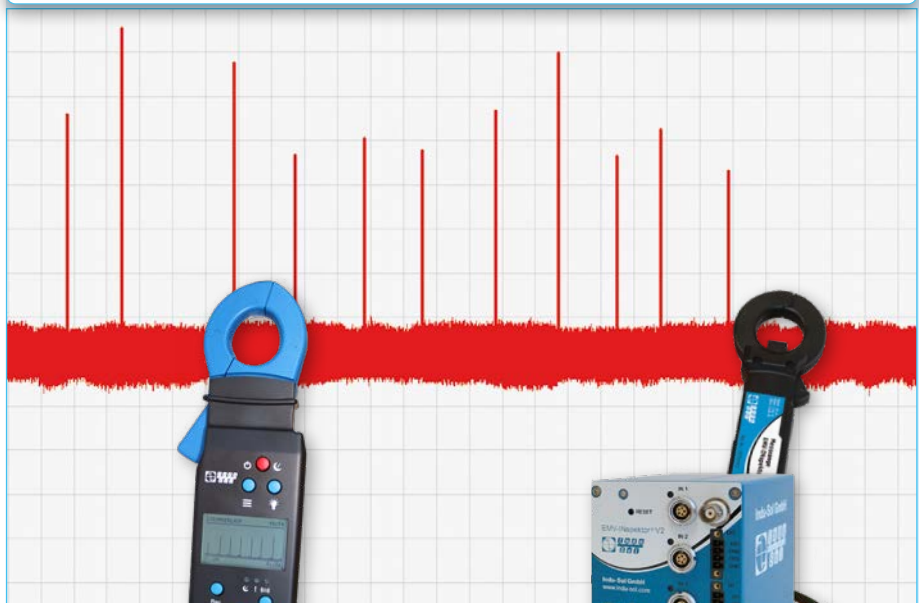

536 mA  
21 mA  
RMS



The EmCheck® ISMZ I displays amplitude in addition to effective value.

536 mA  
21 mA  
RMS



EMV-INspektor® V2 displays effective values and amplitudes for up to 4 clamps.



EmCheck® ISMZ I — EMV-INspektor® V2

### Important characteristics compared

	EmCheck® ISMZ I (mobile)	EMV-INspektor® V2 (stationary)
Measured points	1	4
Function	autonomous measurement, assessing and recording of electromagnetic disturbances	measurement, assessing and recording of electromagnetic disturbances
Sampling rate	choice of 10 kHz, 20 kHz or 40 kHz	50 kHz
Permanent measurement	14 days	permanent
Storage medium	integrated, removeable storage medium (32GB)	integrated storage medium (16GB, extensible via USB port)

### Parallel current measurement with EMV-INspektor® V2

EMV-INspektor® V2 allows the simultaneous evaluation of up to four clamps. For each channel it displays effective values, amplitudes and frequency components. The amplitudes and the spectrum are visualised over time in a diagram.

If a defined threshold value is exceeded the integrated alarm management can, for example, trigger a switch contact or send an email.

### Frequency analysis / spectrum

In addition to the current course, the **EmCheck® View** software calculates the current spectrum. This informs you of the frequency components in the current.

Currents in the kHz range call for different measures to improve the bonding system than at 50/60 Hz. Once you know the pulse frequencies, you can draw conclusions as to potential causes of the disturbance.

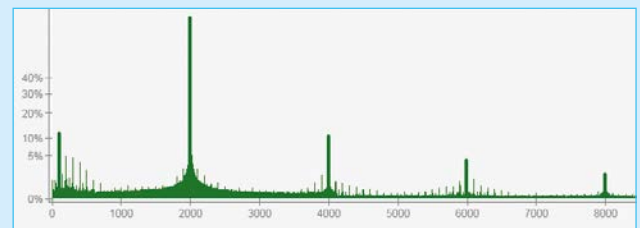

Fig. 22: Display of spectrum with 50 Hz and superimposed 2 kHz

### RECOMMENDATION

By smart long-term monitoring you tap your system for EMC. Our system solution is capable of detecting and localizing conducted interferences. A comprehensive analysis of the measured values allows you to understand the results and provides information on targeted interference reduction.

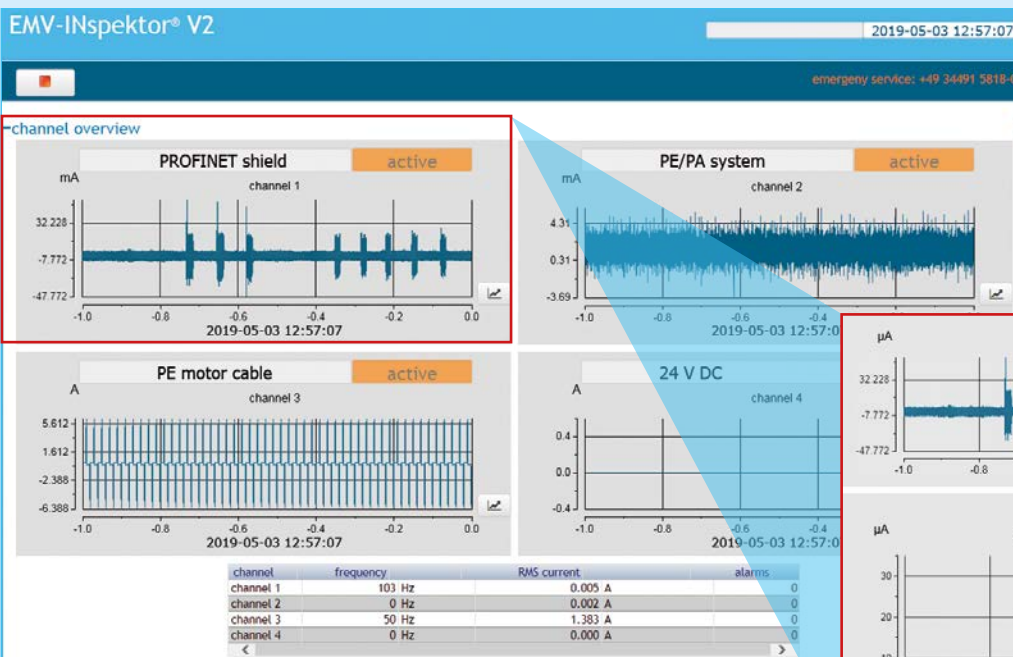
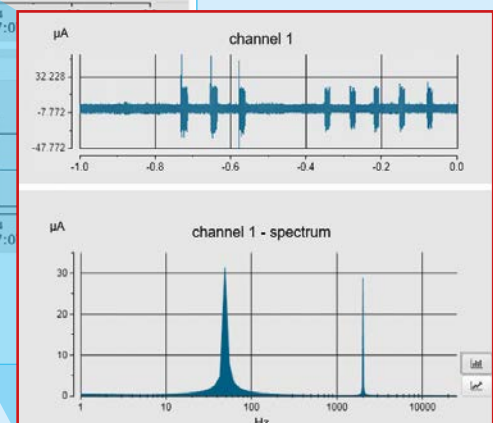

Fig. 24: Clear and detailed display of channels on the Web interface of EMV-INspektor® V2

Fig. 23: Detail view of Channel 1 (amplitude, spectrum and frequency components)



## PROmanage® NT network monitoring software

For preventative, condition-oriented maintenance of PROFINET networks Indu-Sol has developed a strategy for permanent network monitoring (referred to as PNM in the following). It provides for condition monitoring with the goal of “**warning before failure**”.

The concept of PNM calls for continuous analysis of networks through distributed, passive data loggers. In the context of classical fieldbuses like PROFIBUS, CAN, ASi and Ethernet-based networks like PROFINET, Ethercat and Powerlink, the fieldbus-related EMC becomes more and more of a focal point. For this reason, Indu-Sol has expanded the concept of permanent network monitoring to the bus-related EMC. By using the **EMV-INspektor® V2** for distributed data logging, any vagrant currents on bus lines, in the PE/PA system and in the 24 V DC supply can be monitored permanently. Due to the use of measuring clamps, the measurements can be performed during running operation and will cause no interruption. One **EMV-INspektor® V2** can operate four clamps and thus monitor four separate currents.

Whenever a preset threshold value is exceeded this event is stored along with a time stamp. Events are pre-processed by **EMV-INspektor® V2** and chronologically provided to the **PROmanage® NT** network monitoring software for further processing and evaluation.

By means of **PROmanage® NT** the network quality of industrial fieldbuses can be compared to anomalies in the bus-related EMC. This allows conclusions on whether the causes of problems are more likely to be found in the bus itself or rather in its environment. For this purpose it is possible, for example, to superimpose repetitive events in the PROFIBUS and the shield current, chronologically, in a graphic (see Fig. 26).

This sophisticated method of analysis makes irregularities immediately apparent. When a value exceeds or falls below a configurable threshold value an alarm activates. The statistic function keeps data exact to the minute available up to one year. This means historical events can be opened up for viewing at any time for cause analysis, e.g. of sporadic failures. To improve system availability the following targets are set

### Highlights

- Central monitoring of all fieldbuses and networks
- Avoid system failures
- Timely warning via OPC, SNMP trap or email in case of irregularities
- Data exact to the minute available up to one year
- Quick installation
- Easy device set-up due to automatic and manual device scan

for a PNM system:

- Continuous monitoring of real communication
- Complete monitoring and detection of causes of network weaknesses
- Automatic alarms when negative developments occur
- Central overview of all networks





PROmanage NT

**Permanent shield current analysis**

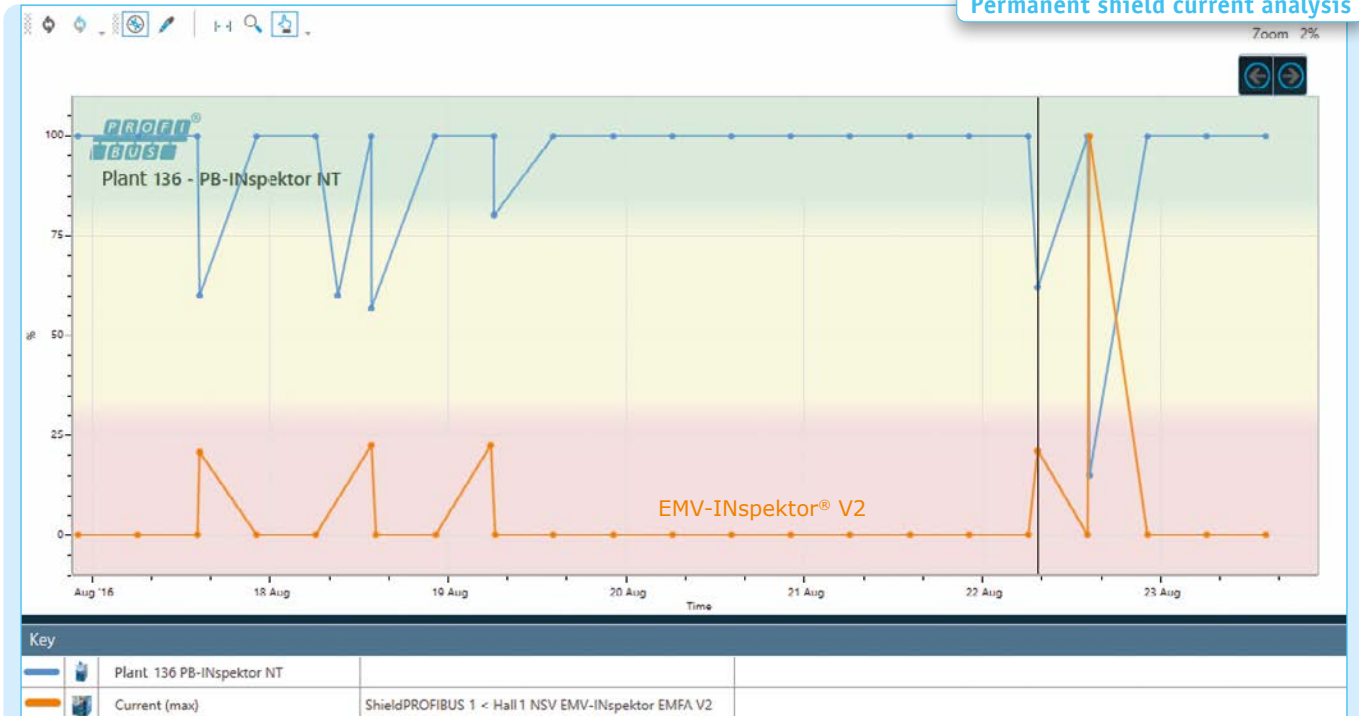

Fig. 25: Permanent shield current analysis compared to PROFIBUS condition graph

**Network history**

How is my network?

The network history provides a quick and clear overview of:

- The current network status
- How long a network has run without error
- When the last error occurred (with time stamp)

**Network history**

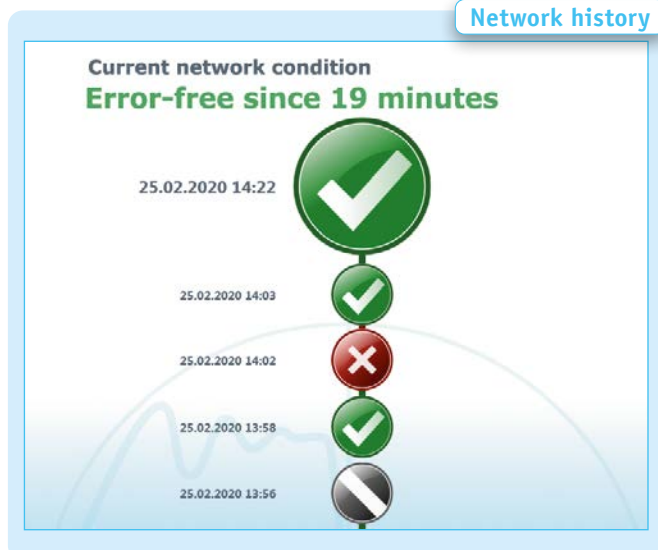

**Network condition graph**

A user-friendly interface can be used to display and evaluate the information. The interface can be adapted to your unique needs and spread over several physical screens for better overview.

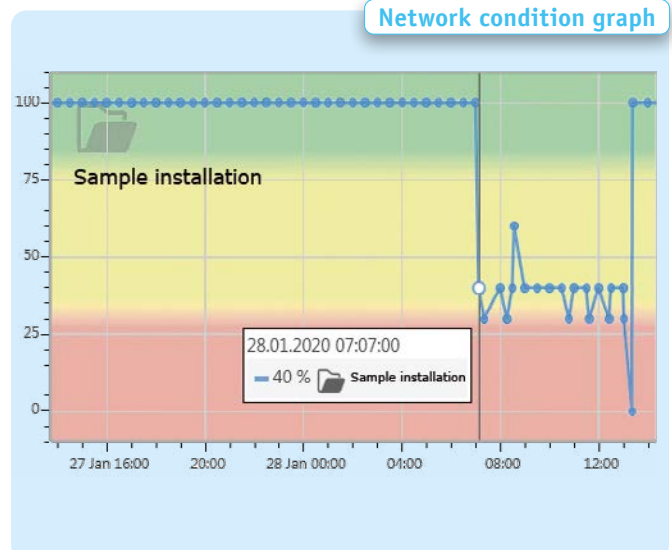

Various parameters of different devices such as device temperature and failures can be compared in a graph to detect links in the event of malfunction.

**Network condition graph**





## Tin-plated copper conductor cables

<p><b>Type of application: fixed installation; class 2</b></p> <p>Available non-insulated, ideal for small-loop bonding systems</p>	<p><b>Type of application: flexible installation; class 5</b></p> <p>Available non-insulated, ideal for small-loop bonding systems</p>	<p><b>Type of application: highly flexible use</b></p> <p>Available non-insulated, ideal for small-loop bonding systems</p>
<p>multistranded</p> <p><b>Class 2</b></p> <p>DIN VDE 0295</p> 	<p>fine-wired</p> <p><b>Class 5</b></p> <p>DIN VDE 0295</p> 	<p>extra fine-wired</p> <p><b>Class 7</b></p> 
<b>Row 1</b>	<b>Row 3</b>	<b>Row 6</b>

Conductor cross-section (mm <sup>2</sup> )	Conductor structure: Number of wires x diameter of single wire (ø in mm)		
<b>6</b>		<b>84 x 0,30</b> Art No. 122040526	<b>1575 x 0,07</b> Art No. 122040601
<b>10</b>	<b>7 x 1,35</b> Art No. 122040500	<b>80 x 0,40</b> Art No. 122040527	<b>2562 x 0,07</b> Art No. 122040603
<b>16</b>	<b>7 x 1,70</b> Art No. 122040501	<b>128 x 0,40</b> Art No. 122040528	<b>4116 x 0,07</b> Art No. 122040604
<b>25</b>	<b>7 x 2,13</b> Art No. 122040502	<b>200 x 0,40</b> Art No. 122040529	<b>6441 x 0,07</b> Art No. 122040605
<b>35</b>	<b>7 x 2,52</b> Art No. 122040503	<b>280 x 0,40</b> Art No. 122040530	<b>4480 x 0,1</b> Art No. 122040606



### How to order the conductor cable you need?

Send us an email under [info@indu-sol.com](mailto:info@indu-sol.com) or call us at **phone no.:** +49 (0) 34491 580-0

When placing your order, please specify the class of conductor cable, the cross-section required for the insulation as well as the quantity. We will provide you with a suitable offer shortly.

**Type of application:  
highly flexible use (e.g. drag chains)**

Available insulated (for drag chains),  
ideal for small-loop bonding systems

<p>Multi-frequency conductor cable</p> <p>lower and higher frequency compatible</p>	<p>extra fine-wired</p> <p><b>Class 7 isolated</b></p>	<p>extra-fine wired (suitable for torsion)</p> <p><b>Class 8 „UL“</b></p> <p>suitable for use in robots</p>
	 <p>Row 6</p>	

<p><b>1575 x 0,07 + 96 x 0,1</b></p> <p>Art No. 122040901</p>	<p><b>1575 x 0,07</b></p> <p>Art No. 122040721</p>	<p><b>1575 x 0,07</b></p>
<p><b>2562 x 0,07 + 128 x 0,1</b></p> <p>Art No. 122040903</p>	<p><b>2562 x 0,07</b></p> <p>Art No. 122040723</p>	<p><b>2562 x 0,07</b></p> <p>Art No. 122041103</p>
<p><b>4116 x 0,07 + 192 x 0,1</b></p> <p>Art No. 122040904</p>	<p><b>4116 x 0,07</b></p> <p>Art No. 122040724</p>	<p><b>4116 x 0,07</b></p> <p>Art No. 122041104</p>
	<p><b>6441 x 0,07</b></p> <p>Art No. 122040725</p>	<p><b>6441 x 0,07</b></p>



**RECOMMENDATION**

Please use the conductor cables preferably with the fastening elements of the **EmClots®** system. (p. 14-15, p.30)

## Infrastructure components

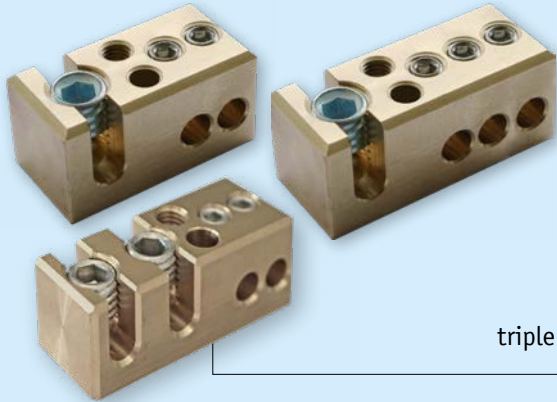

triple

### EmClots® Junction V2 (see page 14)

Terminal (for 4 - 16 mm<sup>2</sup> or 25 - 35 mm<sup>2</sup>)

Ordering Details	Art.-No.
EmClots® Junction V2 (4 - 16 mm <sup>2</sup> )	122180100
EmClots® Junction V2 (25 - 35 mm <sup>2</sup> )	122180101
EmClots® Junction V2 triple (4 - 16 mm <sup>2</sup> )	122180110
EmClots® Junction V2 triple (25 - 35 mm <sup>2</sup> )	122180111
EmClots® Junction V2 (4 - 16 mm <sup>2</sup> ) GRID	122180120

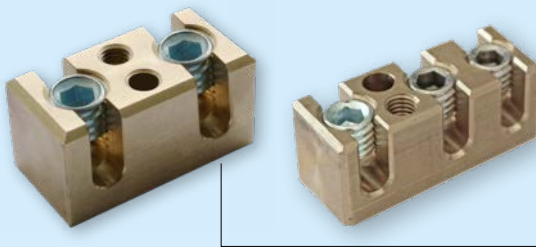

### EmClots® Connector V2 (see page 14)

Terminal (for 4 - 16 mm<sup>2</sup> or 25 - 35 mm<sup>2</sup>)

Ordering Details	Art. No.
EmClots® Connector V2 (4 - 16 mm <sup>2</sup> )	122180200
EmClots® Connector V2 (25 - 35 mm <sup>2</sup> )	122180201
EmClots® Connector V2 (4 - 16 mm <sup>2</sup> ) GRID	122180220



### EmClots® Fastening V2 (see page 14)

Terminal (for 4 - 16 mm<sup>2</sup> or 25 - 35 mm<sup>2</sup>)

Ordering Details	Art. No.
EmClots® Fastening V2 (4 - 16 mm <sup>2</sup> )	122180300
EmClots® Fastening V2 (25 - 35 mm <sup>2</sup> )	122180301

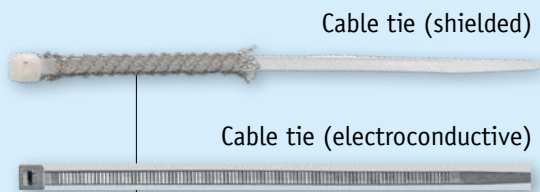

Cable tie (shielded)

Cable tie (electroconductive)

### Cable ties (shielded, electroconductive)

Ordering Details	Art. No.
Cable tie shielded (Shield braid 40)	122100132
Cable tie shielded (Shield braid 60)	122100136
Cable tie electroconductive (L=140 mm x B=3,6 mm)	122100067
Cable tie electroconductive (L=290 mm x B=4,8 mm)	122100068
Cable tie electroconductive (L=365 mm x B=7,8 mm)	122100069

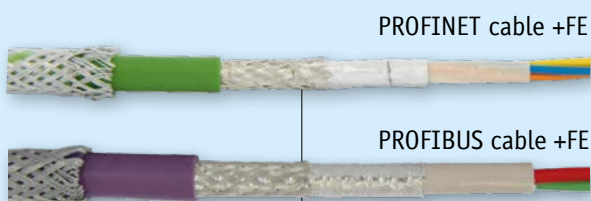

PROFINET cable +FE

PROFIBUS cable +FE

### PROFINET/PROFIBUS cable +FE (see page 17)

Ordering Details	Art. No.
PROFINET cable +FE (type b - flexible)	114060003
PROFIBUS cable +FE (flexible)	110070018

\*EmClots® fastening elements – optimal in combination with the appropriate conductor cables (p. 28-29)

## Infrastructure components



**EmFlex stripping tool** (see page 16)

Ordering Details	Art. No.
EmFlex Stripping Tool	122130010



**EMC STARTERBOX** (see page 16)  
galvanized clamping range

Ordering Details	Art. No.
EMV-STARTERBOX	122160500

### Contents of EMC STARTERBOX



**EmClip® shield terminal SKSZ**

Ordering Details	Number	Art. No.
SKSZ 3-6 (galvanized)	4	122160081
SKSZ 6-8 (galvanized)	4	122160082
SKSZ 8-11 (galvanized)	4	122160083
SKSZ 11-16 (galvanized)	4	122160084



**EmClip® shield terminal SKDZ M4**

Ordering Details	Number	Art. No.
SKDZ M4 3-6 (galvanized)	4	122160041
SKDZ M4 6-8 (galvanized)	4	122160042
SKDZ M4 8-11 (galvanized)	4	122160043
SKDZ M4 11-16 (galvanized)	4	122160044

## Infrastructure components

### Contents of EMC STARTERBOX



### EmClip® shield terminal SKHZ

Ordering Details	Number	Art. No.
SKHZ 3-6 (galvanized)	4	122160001
SKHZ 6-8 (galvanized)	4	122160002
SKHZ 8-11 (galvanized)	4	122160003
SKHZ 11-16 (galvanized)	4	122160004



### EmClip® shield terminal SKSZ Duo

Ordering Details	Number	Art. No.
SKSZ Duo 3-6 (galvanized)	1	122160090
SKSZ Duo 6-8 (galvanized)	1	122160091
SKSZ Duo+ 3-12 (galvanized)	1	122160092



### EmClip® shield terminal MSK multi

Ordering Details	Number	Art. No.
MSK multi 3-12 (galvanized)	5	122160147
MSK multi 7-18 (galvanized)	5	122160148



### EmClip® shield terminal MSK

Ordering Details	Number	Art. No.
MSK 3-6 (galvanized)	5	122160141
MSK 6-8 (galvanized)	5	122160142
MSK 8-11 (galvanized)	5	122160143
MSK 11-16 (galvanized)	5	122160144

## Infrastructure components

### Contents of EMC STARTERBOX



### EmClip® shield terminal MDZ for direct mounting

Ordering Details	Number	Art. No.
for direct mounting (galvanized)	10	122160122

### EmClip® shield terminal MSZ for bus bar

Ordering Details	Number	Art. No.
for bus bar (galvanized)	10	122160124

### EmClip® shield terminal MHZ for top-hat rail

Ordering Details	Number	Art. No.
for top-hat rail (galvanized)	10	122160120

### Motor cable SymFlex® EMV-Drive (see page 18)

### Motor cable SymFlex® EMV-Drive +FE\*

Symmetric motor cable

Cross-sections  
up to 240 mm<sup>2</sup>

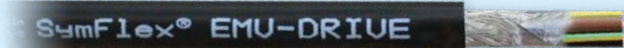

SymFlex® EMV-Drive (Art.-Nr.: **X** = 0)  
e.g.

SymFlex® EMV-DRIVE (3 x 4,0 + 3 G 0,75)	122020 <b>0</b> 02
---	--------------------



SymFlex® EMV-Drive +FE (Art.-Nr.: **X** = 1)  
e.g.

SymFlex® EMV-DRIVE +FE (3 x 4,0 + 3 G 0,75)	122020 <b>1</b> 02
---	--------------------

Ordering Details	Art. No.
SymFlex® EMV-DRIVE/+FE (3 x 1,5 + 3 G 0,25)	122020 <b>X</b> 00
SymFlex® EMV-DRIVE/+FE (3 x 2,5 + 3 G 0,5)	122020 <b>X</b> 01
SymFlex® EMV-DRIVE/+FE (3 x 4,0 + 3 G 0,75)	122020 <b>X</b> 02
SymFlex® EMV-DRIVE/+FE (3 x 6,0 + 3 G 1,0)	122020 <b>X</b> 03
SymFlex® EMV-DRIVE/+FE (3 x 10,0 + 3 G 1,5)	122020 <b>X</b> 04
SymFlex® EMV-DRIVE/+FE (3 x 16,0 + 3 G 2,5)	122020 <b>X</b> 05
SymFlex® EMV-DRIVE/+FE (3 x 25,0 + 3 G 4)	122020 <b>X</b> 06
SymFlex® EMV-DRIVE/+FE (3 x 35,0 + 3 G 6)	122020 <b>X</b> 07
SymFlex® EMV-DRIVE/+FE (3 x 50,0 + 3 G 10)	122020 <b>X</b> 08
SymFlex® EMV-DRIVE/+FE (3 x 70,0 + 3 G 10)	122020 <b>X</b> 09
SymFlex® EMV-DRIVE/+FE (3 x 95,0 + 3 G 16)	122020 <b>X</b> 10
SymFlex® EMV-DRIVE/+FE (3 x 120,0 + 3 G 16)	122020 <b>X</b> 11
SymFlex® EMV-DRIVE/+FE (3 x 150,0 + 3 G 25)	122020 <b>X</b> 12
SymFlex® EMV-DRIVE/+FE (3 x 185,0 + 3 G 35)	122020 <b>X</b> 12
SymFlex® EMV-DRIVE/+FE (3 x 240,0 + 3 G 50)	122020 <b>X</b> 12

\*Reduced quantities on request.

## Measurement and diagnostic tools



### EmCheck® LSMZ I (see page 20)

Leakage current measuring clamp

Ordering Details	Art. No.
EmCheck® LSMZ I	122010005
Set of measuring clamps (LSMZ I and MWMZ II)	122010006
Set of measuring clamps XL (LSMZ, MWMZ II and ISMZ)	122010007



### EmCheck® MWMZ II (see page 21)

Mesh resistance measuring clamp

Ordering Details	Art. No.
EmCheck® MWMZ II	122010010
Set of measuring clamps (LSMZ I and MWMZ II)	122010006
Set of measuring clamps XL (LSMZ, MWMZ II and ISMZ)	122010007



### EmCheck® ISMZ I (see page 22)

Intelligent current measuring clamp

Ordering Details	Art. No.
EmCheck® ISMZ I	122010020
Set of measuring clamps XL (LSMZ, MWMZ II and ISMZ)	122010007

INDUSTRIE  
PREIS 2017  
BEST OF



### EMV-INSpektor® V2 (see page 23)

Measuring and analysing tool

Ordering Details	Art. No.
EMV-INSpektor® V2 incl. 1 clamp	122010001
Additional measuring and diagnostic clamp	122010002

INDUSTRIE  
PREIS 2018  
BEST OF

## Permanent network monitoring



### PROmanage® NT V2 (see page 24)

Network monitoring software

\*The licence defines the maximum number of network ports or devices retrieved simultaneously. (Ethernet switch: number of network ports = number of licence ports, 1 PB-INSpektor® = 8 ports, 1 PN-INSpektor® = 16 ports)

Ordering Details	Art. No.
Upgrade NT to NT V2	117000100
PROmanage® NT (80 Ports*)	117000104
PROmanage® NT (320 Ports*)	117000106
PROmanage® NT (640 Ports*)	117000110

\*Further licences upon request

## Our expertise



## Our range of services

### Situation analysis

- Evaluation of protective and functional potential, minus potential 24V DC
- Shield currents of data line, depending on communication quality
- Compilation of comprehensive measurement log

### Target state

- Suggestions for optimising equipotential bonding in accordance with VDE 50310
- Compilation of action concept with list of material preferences
- Consultation and support during construction

### Material

- Supply of specified contact and connection elements
- Tin-plated copper conductor cables according to DIN VDE classification

### Evaluation

- Acceptance and test log
- Certificate – Confirmation, recommendations from applicable standards and directives

### Training/qualification

- Basic principles and relationships – Protective and functional potential
- Targeted expertise in the field of EMC
- Workshop – From the field, for the field

## Measurement | Training



## Measurement / Troubleshooting

Network analysis / Certification, Troubleshooting

### Ordering Details

Art. No.

EMC & Equipotential bonding

210060000

## Training

EMV training (2 days)

### Ordering Details

Art. No.

EMC & Equipotential bonding  
(2 days Schmoelln)\*

220060002

Workshop - grounding and shielding of  
PROFIBUS and PROFINET (1 day-extern)

220060005

\*On-site training at your premises.

A large, stylized sun graphic in shades of orange and yellow, centered on the page. The sun has a circular core with several curved rays extending outwards. The background is a solid orange color.

**Indu-Sol GmbH**  
Blumenstrasse 3  
04626 Schmoelln

Telephone: +49 (0) 34491 580-0  
Telefax: +49 (0) 34491 580-499

[info@indu-sol.com](mailto:info@indu-sol.com)  
[www.indu-sol.com](http://www.indu-sol.com)

Certified according to DIN EN ISO 9001:2015